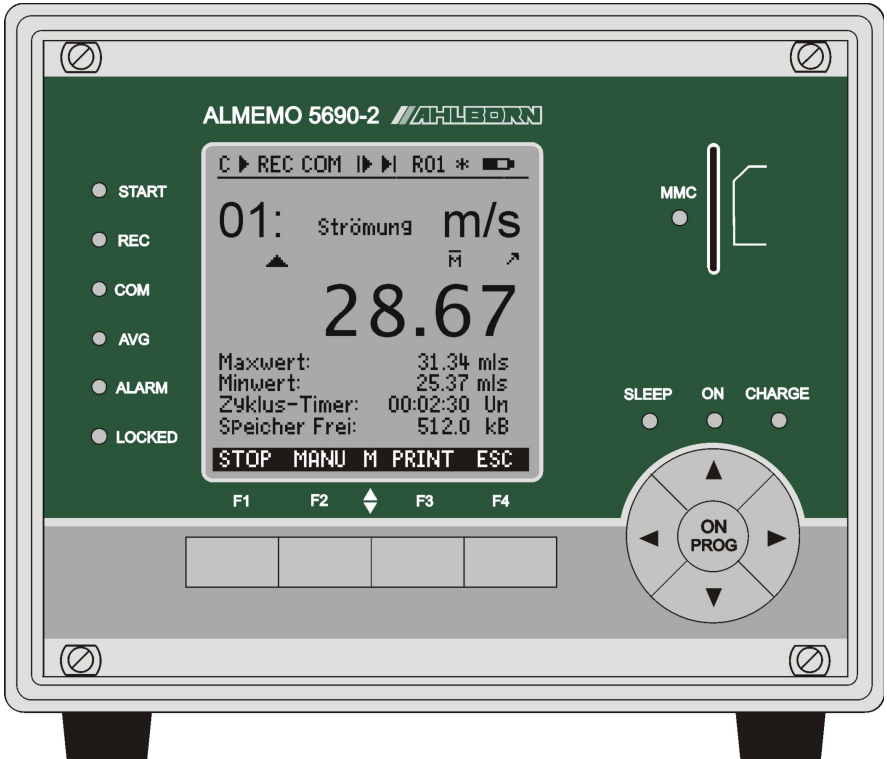

# Operating instructions

english

**V6**

## Data acquisition system

# ALMEMO® 5690-2M

V4.1  
15/03/2013

# 1. OPERATING CONTROLS

## 1.1 Front panel

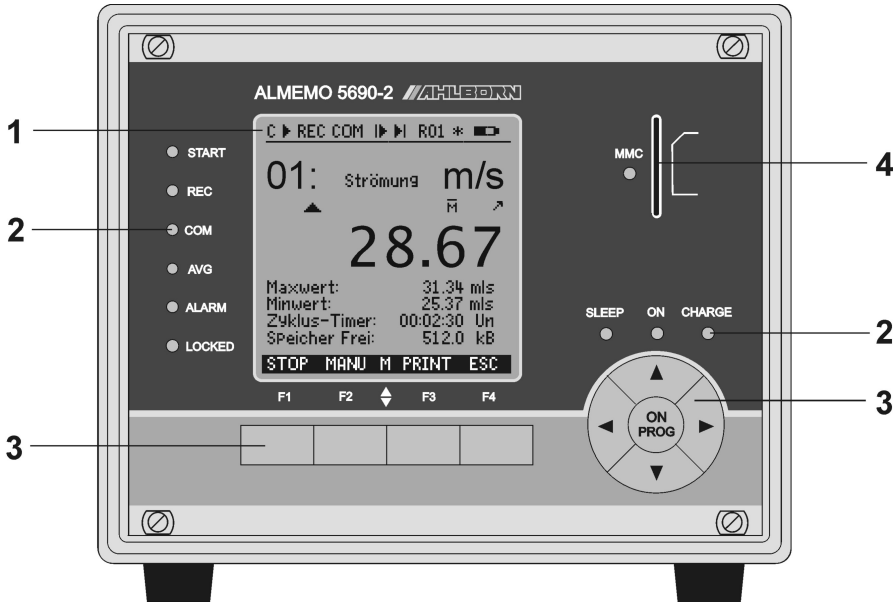

### (1) LCD

#### Status bar

<b>C</b>	Cont. Measuring point scan
<b>▶,   </b>	Start / stop measuring
<b>REC</b>	Record to memory
<b>COM</b>	Measured value output
<b>▶▶</b>	Program start / end of measuring
<b>R01</b>	Status of alarm relays
<b>*, *</b>	Lighting on, pause
<b>🔋</b>	Battery operation / charge status

#### 13 lines for functions

#### Function of keys F1, F2, F3, F4

### (2) Check lamps

<b>START</b>	Measuring operation started
<b>REC</b>	Measuring with results saved
<b>COM</b>	Measuring with output
<b>AVG</b>	Averaging
<b>ALARM</b>	Limit value exceeded
	Sensor breakage, LoBat
<b>LOCKED</b>	Keys locked

### (2) Check lamps

<b>ON</b>	Device is on.
<b>SLEEP</b>	Flashes in sleep mode.
<b>CHARGE</b>	Battery is being charged.

charged.

### (3) Keypad

**F1** to **F4** Function keys (soft keys)

#### Cursor block

<b>ON</b>	Switch on
<b>PROG</b>	Program
	Switch OFF ( <u>press and</u>

hold down)

<b>▲, ▼, ▶</b>	Function selection, input
<b>◀</b>	Last menu

### (4) Slot, multimedia card

**SD** Slot for memory card

## 1.2 Rear

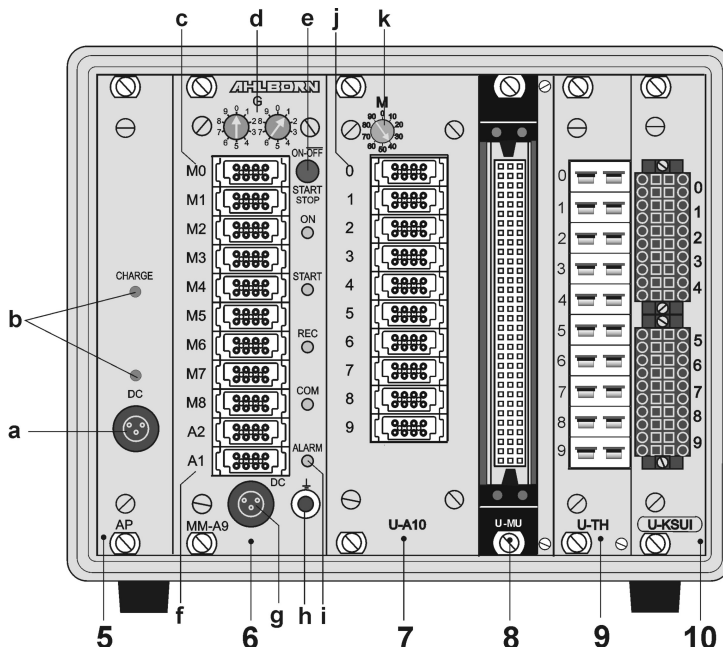
**(5) Module AP rechargeable battery (option)****(a) Connection socket DC-A 12V**

Mains adapter (ZB 1212-NA9, 12V, 2.5A)

**(b) Check lamps**

DC-A Mains supply present  
 CHARGE Battery is being charged.  
 Goes out as soon as fully charged.

**(6) Module MM-A9  
Measuring circuit board  
ALMEMO****(c) Measuring inputs M0 to M8**

M0 to M8 for all ALMEMO sensors  
 M9 to M39 31 additional channels

**(d) Code switches**

G: Device address 0 to 99

**(e) Key ON/OFF, START/STOP**

No function

**(f) Output sockets A1, A2**

A1 Interface / optic fiber (ZA1909-DK5/L)  
 RS 422 (ZA 5099-NVL/NVB)  
 Ethernet (ZA 1945-DK)  
 Bluetooth (ZA 1709-BTx)  
 A2 Network cable (ZA1999-NK5/NKL)  
 A1/A2 Trigger input (ZA 1000-ET/EK)  
 Relay outputs (ZA 1000-EGK)  
 Analog output 2 (ZA 1601-RK)

**(g) Connection socket DC 12V**

Mains adapter (ZB 1212-NA6, 12V, 3A)  
 Cable, electr. isol. (ZB 3090-UK2, 10-30V)

**(h) Ground socket****(i) Check lamps**

ON Device is on.  
 START Measuring operation started  
 REC Measuring with results saved  
 COM Measuring with output  
 ALARM Limit value exceeded  
 Sensor breakage, LoBat



## 2. CONTENTS

<b>1. OPERATING CONTROLS</b> .....	<b>2</b>
1.1 Front panel .....	2
1.2 Rear .....	3
<b>3. GENERAL</b> .....	<b>8</b>
3.1 Warranty .....	8
3.2 Scope of delivery .....	9
3.3 Waste disposal.....	9
<b>4. SAFETY INSTRUCTIONS</b> .....	<b>10</b>
4.1 Special notes on use.....	11
4.2 Handling batteries / rechargeable batteries correctly.....	11
<b>5. INTRODUCTION</b> .....	<b>12</b>
5.1 Functions of the ALMEMO 5690-2M .....	12
5.1.1 Sensor programming.....	13
5.1.2 Measuring operations .....	14
5.1.3 Process control .....	15
<b>6. INITIAL COMMISSIONING</b> .....	<b>17</b>
<b>7. POWER SUPPLY</b> .....	<b>18</b>
7.1 Mains operation .....	18
7.2 External DC voltage supply .....	18
7.3 Operation with rechargeable battery (only with module ES5690-AP).....	18
7.4 Sensor supply .....	19
7.5 Switching ON / OFF, Reinitialization .....	19
7.6 Data buffering .....	19
<b>8. CONNECTING THE TRANSDUCERS</b> .....	<b>20</b>
8.1 Transducers .....	20
8.2 Measuring inputs and additional channels .....	20
8.3 Extending the measuring points .....	21
8.4 Potential separation .....	22
<b>9. RELAY TRIGGER ANALOG MODULE</b> .....	<b>24</b>
9.1 Power supply .....	24
9.2 Interface elements and options .....	24
9.2.1 Relays .....	25
9.2.2 Trigger inputs .....	25
9.2.3 Analog outputs .....	25
9.2.4 Connecting peripheral equipment .....	26
9.2.5 Putting into service .....	26
9.3 Technical data .....	26
<b>10. DISPLAY AND KEYPAD</b> .....	<b>27</b>
10.1 Display and menu selection .....	27
10.2 Status symbols in the display and status LEDs .....	28
10.3 Function keys .....	28
10.4 Function selection .....	29

10.5 Data input .....	29
<b>11. MEASURING WITH THE MEASURING MENUS .....</b>	<b>30</b>
<b>11.1 Measuring with a measuring point .....</b>	<b>31</b>
11.1.1 Selecting a measuring point .....	31
11.1.2 Peak value memory with date and time-of-day .....	31
<b>11.2 Measured value correction and compensation .....</b>	<b>32</b>
11.2.1 Set measured value to zero .....	32
11.2.2 Zero-point adjustment .....	33
11.2.3 Sensor adjustment for chemical sensors and probes .....	33
11.2.4 Two-point adjustment with setpoint entry .....	34
11.2.5 Temperature compensation .....	35
11.2.6 Atmospheric pressure compensation .....	35
11.2.7 Cold junction compensation .....	36
<b>11.3 Measuring point scan and output .....</b>	<b>37</b>
11.3.1 Once-only output / saving of all measuring points .....	37
11.3.2 Cyclic output / saving of all measuring points .....	37
11.3.3 Memory space, memory output, clearing the memory .....	38
11.3.4 Output menu functions.....	38
11.3.5 Displaying measured values as a line graph .....	39
<b>11.4 Averaging.....</b>	<b>40</b>
11.4.1 Smoothing out meas. val. by means of a sliding average .....	41
11.4.2 Averaging mode.....	41
11.4.3 Averaging over individual manual measuring .....	41
11.4.4 Networked measuring .....	42
11.4.5 Averaging over the measuring time,measuring duration .....	43
11.4.6 Measuring time, measuring duration, timer.....	43
11.4.7 Averaging over the cycle .....	44
11.4.8 Averaging over measuring points .....	45
11.4.9 Volume flow measurement.....	46
<b>11.5 Display of several measuring points .....</b>	<b>47</b>
11.5.1 Menu Multi-channel display and bar charts .....	47
11.5.2 Differential measurement .....	47
11.5.3 Menu Measuring points list .....	48
<b>11.6 Wizard menus for special measuring operations .....</b>	<b>49</b>
11.6.1 Thermal coefficient .....	49
11.6.2 Wet bulb globe temperature.....	49
<b>11.7 User menus .....</b>	<b>50</b>
11.7.1 Functions.....	50
11.7.2 Menu configuration .....	51
11.7.3 Function printouts.....	52
<b>12. PROGRAMMING USING THE PROGRAMMING MENUS .....</b>	<b>53</b>
<b>12.1 Times and cycles .....</b>	<b>53</b>
12.1.1 Date and time-of-day .....	53
12.1.2 Cycle with memory activation and output format.....	53

12.1.3 Measuring rate, continuous measuring point scan.....	54
12.1.4 Start time Start date End time End date Measuring duration... ..	55
<b>12.2 Measured value memory .....</b>	<b>56</b>
12.2.1 Memory with memory card.....	56
12.2.2 Measured data, recording.....	57
12.2.3 Numbering of measuring operations.....	58
12.2.4 Starting and stopping measuring operations.....	58
12.2.5 Scanning mode.....	58
12.2.6 Memory output.....	60
<b>12.3 Sensor programming.....</b>	<b>61</b>
12.3.1 Selecting the input channel.....	62
12.3.2 Measuring point designation .....	62
12.3.3 Averaging mode.....	63
12.3.4 Locking the sensor programming.....	63
12.3.5 Limit values.....	64
12.3.6 Scaling, Decimal point setting.....	64
12.3.7 Correction values.....	65
12.3.8 Changing the units.....	65
12.3.9 Selecting the measuring range.....	65
12.3.10 Function channels .....	68
12.3.11 Special measuring ranges ,Linearization ,Multi-point calibration .....	70
<b>12.4 Special functions.....</b>	<b>70</b>
12.4.1 Print cycle factor .....	71
12.4.2 Minimum sensor power supply .....	71
12.4.3 Limit Value Responses .....	72
12.4.4 Analog start and analog end .....	73
12.4.5 Output function .....	73
12.4.6 Reference channel 1.....	74
12.4.7 Reference channel 2 or multiplexer .....	74
12.4.8 Element flags.....	74
<b>12.5 Device configuration .....</b>	<b>75</b>
12.5.1 Device designation.....	75
12.5.2 Device address and networking.....	75
12.5.3 Baud rate, Data format.....	76
12.5.4 Language .....	76
12.5.5 Backlighting and contrast.....	76
12.5.6 Atmospheric pressure.....	76
12.5.7 Hysteresis.....	77
12.5.8 Operating parameters.....	77
<b>12.6 Output modules .....</b>	<b>77</b>
12.6.1 Data cables .....	78
12.6.2 relay trigger analog modules .....	78
12.6.3 Analog output .....	80

12.7 Power supply menu.....	81
12.8 Locking, calibration menu (option KL).....	81
13. TROUBLE-SHOOTING .....	83
14. DECLARATION OF CONFORMITY.....	84
15. APPENDIX.....	85
15.1 Technical data .....	85
15.2 Index.....	87
15.3 Your contact person.....	93

## 3. GENERAL

Congratulations on your purchase of this new and innovative ALMEMO® data acquisition system. Thanks to the patented ALMEMO® connector the device configures itself automatically and thanks to the supplied AMR-Control software its operation should be fairly straightforward. The device can, however, be used with such a wide range of sensors and peripherals and offers many different special functions. You are advised therefore to properly familiarize yourself with the way the sensors function and with the device's numerous possibilities and take the time to carefully read these operating instructions and the appropriate sections in the ALMEMO® Manual. This is absolutely necessary to avoid operating and measuring errors and to prevent damage to the device. To help you find the answers to your questions quickly and easily there is a comprehensive index at the end both of these instructions and of the Manual.

### 3.1 Warranty

Each and every device, before leaving our factory, undergoes numerous quality tests. We provide a guarantee, lasting two years from delivery date, that your device will function trouble-free. Before you send your device to us, please observe the advisory notes in Chapter 13. Trouble-shooting In the unlikely event that the device proves defective and you need to return it please wherever possible use the original packaging material for dispatch and enclose a clear and informative description of the fault and of the conditions in which it occurs.

This guarantee will not apply in the following cases :

- The customer attempts any form of unauthorized tampering and alteration inside the device.
- The device is used in environments and conditions for which it is not suited.
- The device is used with unsuitable power supply equipment and peripherals.
- The device is used for any purpose other than that for which it is intended.
- The device is damaged by electrostatic discharge or lightning.
- The user fails to observe and respect the operating instructions.

The manufacturer reserves the right to change the product's characteristics in the light of technical progress or to benefit from the introduction of new components.



### 3.2 Scope of delivery

When you unpack the device check carefully for any signs of transport damage and that delivery is complete.

Measuring instrument ALMEMO® 5690-2M

SD card and USB card reader

Mains adapter ZB1212-NA9 12V, 2.5A

These operating instructions

ALMEMO® Manual

CD with the AMR-Control software and various useful accessories

In the event of transport damage please retain the packaging material and inform your supplier immediately.

### 3.3 Waste disposal

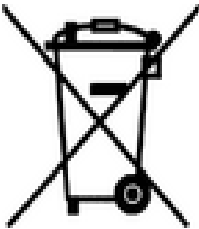

The pictogram showing a waste bin crossed through means that the product is subject to European Union regulations on segregated waste disposal. This applies both to the product itself and to any accessories marked with the same symbol. Disposal of any such item as unsorted domestic waste is strictly forbidden

- Please dispose of all packaging materials according to the applicable national waste management regulations.
- Please dispose of cardboard boxes, protective plastic packaging materials, and all preservative substances separately and in the proper manner.
- The disposal of the device itself (also of device parts, accessories, and consumables) is subject to the applicable national and local waste management regulations and to the environmental protection legislation in force in the country of use.
- Please dispose of all waste in the proper manner; this applies in particular to all parts and substances that constitute a hazard for the environment. This includes inter alia plastics, batteries, and rechargeable battery packs .
- When disposing of goods, please wherever possible use the original packaging materials.

## 4. SAFETY INSTRUCTIONS

**DANGER** Danger to life and limb, risk of damage to equipment



Read the instructions carefully before starting to operate the device.

Please ensure that you comply with all general safety advice and the special safety instructions included in other chapters.

Such risks may occur in the following circumstances :

- Failure to heed the operating instructions and all the safety notes these contain
- Any form of unauthorized tampering or alteration inside the device
- Use of the device in environments or conditions for which it is not suited
- Use of the device with an unsuitable power supply and / or in conjunction with unsuitable peripheral equipment
- Use of the device for any purpose other than that for which it is intended
- Damage caused by electrostatic discharge or lightning.

---

**DANGER** Risk of fatal injury caused by dangerously high voltage



Such risks may occur in the following circumstances :

- Use of the device with an unsuitable power supply and / or in conjunction with unsuitable peripheral equipment
  - Damage caused by electrostatic discharge or lightning
  - Do not run sensor lines in the vicinity of high-voltage power cables.
  - Before you touch any sensor lines, ensure that all static electricity has been discharged.
-

**DANGER Warning - explosive atmospheres or substances**

In the vicinity of various fuels or chemicals there is a risk of explosion.



Do not use the device in the close vicinity of blasting work or filling stations!

**4.1 Special notes on use**

- If the device is brought into the work-room from a cold environment there is a risk that condensation might form on the electronics. In measuring operations involving thermocouples pronounced changes in temperature may cause substantial measuring errors. You are advised therefore to wait until the device has adjusted to the ambient temperature before starting to use it.
- Before using the mains adapter make sure that the mains voltage is suitable.
- Be sure to observe the maximum load capacity of the sensor power supply.
- Sensors with their own integrated power supply are not electrically isolated from one another

**4.2 Handling batteries / rechargeable batteries correctly**

When inserting batteries / rechargeable batteries ensure that these are correctly polarized.

If the device will probably not be needed for a relatively long period of time or if the batteries are empty, remove the batteries; this will prevent battery acid leaking onto the device and damaging it.

Rechargeable batteries should be recharged as and when necessary.

You should never attempt to recharge an ordinary (non-rechargeable) battery; it may explode !

Batteries / rechargeable batteries must never be short-circuited or thrown onto the fire.

Batteries / rechargeable batteries are special waste and must not be discarded together with normal domestic waste.

## 5. INTRODUCTION

The data acquisition system **ALMEMO®** 5690-2M is a new member in our family of unique measuring devices - all equipped with Ahlborn's patented ALMEMO® connector system. The intelligent ALMEMO® connector offers decisive advantages when connecting sensors and peripherals because all parameters are stored in an EEPROM located on the connector itself; repeat programming is thus no longer necessary.

All sensors and output modules can be connected to all ALMEMO® measuring instruments in the same way. Programming and functioning are identical for all units. The following points apply to all devices in the ALMEMO® measuring system; these are described in detail in the ALMEMO® Manual which is included in delivery with each device.

- Detailed explanation of the ALMEMO® system (Manual Ch 1)

- Overview of the device functions and measuring ranges (Manual Ch 2)

- Basic principles, operation, and technical data for all sensors (Man. Ch 3)

- Options for connecting your own existing sensors (Manual Ch 4)

- All analog and digital output modules (Manual 5.1)

- Interface modules RS-232, optic fiber (Manual 5.2)

- The whole ALMEMO® networking system (Manual 5.3)

- All functions and their operation via the interface (Manual Ch 6)

- Complete list of interface commands with all the print layouts (Man. Ch 7)

The operating instructions you are now reading cover only those features and controls that are specific to this device. Many sections therefore also refer to the more detailed description in the Manual; (see Manual, Section xxx).

### 5.1 Functions of the ALMEMO 5690-2M

The data acquisition system ALMEMO® 5690-2M has basically 9 electrically isolated measuring inputs with over 70 measuring ranges - suitable for all ALMEMO® sensors. This number can, using various selector switch boards, be extended to 99 inputs. To accommodate these various expansion stages the desktop housing is available in 32-DU / 84-DU sizes and a 19-inch rack is available. For operation purposes the device incorporates an LCD graphics display and a soft-key keypad with cursor block. The display can be adapted by means of configurable user menus to suit any application. Thanks to the real-time clock incorporated as standard and with a SD card the amount of data you can record is virtually endless. A variant is available with an integrated 512-KB EEPROM memory sufficient for approx. 100,000 measured values. With optionally Module RTA5 available to 10 internal connections any ALMEMO® output modules, e.g. analog output, digital interface, trigger input, or alarm contacts. Several devices can be networked by simply linking them together via cable.

The system is fed by default via a 12-V mains adapter. There is also the option of using a rechargeable battery module.

### 5.1.1 Sensor programming

The measuring channels are programmed, completely and automatically, by the ALMEMO® connectors. However, the user can easily supplement or modify this programming via the keypad or via the interface.

#### Measuring ranges

Appropriate measuring ranges are available for all sensors with a non-linear characteristic, e.g. 10 thermocouple types, NTC and PT100 probes, infrared sensors, and flow transducers (rotating vanes, thermoanemometers, Pitot tubes). For humidity sensors additional function channels are available for calculating humidity variables such as dew point, mixture ratio, vapor pressure, and enthalpy. Even complex chemical sensors are supported. Measured values from other sensors can also be acquired using the voltage, current, and resistance ranges with individual scaling in the connector. Existing sensors can also be used - so long as the appropriate ALMEMO® connector is connected via its screw terminals. For digital input signals, frequencies, and pulses, adapter connectors are available with an integrated microcontroller. It is thus possible to connect virtually any sensor to any ALMEMO® measuring instrument and to change sensors without the need for any extra settings.

#### Function channels

Maximum, minimum, average, and differential values from certain measuring points can be programmed as function channels, also internal channels, and can be processed and printed out like normal measuring points. There are also function channels available for special measuring tasks, e.g. to determine the temperature coefficient  $Q/\Delta T$  and wet bulb globe temperature.

#### Units

The 2-character units display can be adapted for each measuring channel so that both the display and the printout always indicate the correct units, e.g. when a transmitter is connected. Conversion between °C and °F is performed automatically.

#### Measured value designation

Each sensor is identified by means of a 10-character alphanumeric name. It is entered via the keypad or the interface and appears in the display, in the printout, or on the computer screen.

#### Correction of measured values

The measured value on each measuring channel can be corrected both in terms of zero-point and gain; this means that even sensors usually requiring initial adjustment (e.g. expansion, force, pH) can be freely interchanged. Zero-point correction and, partly at least, gain adjustment can be performed at the touch of a button.

#### Scaling

The corrected measured value on each measuring channel can also be further scaled in terms of zero-point and gain - using the base value and factor. The decimal point position can be set by means of the exponent function. The scaling values can be calculated automatically by setting to zero and entering the

nominal setpoint or via the scaling menu.

### **Limit values and alarm**

Per measuring channel two limit values can be set (1 maximum and 1 minimum). In the event of one of these limit values being exceeded an alarm signal is output and relay output modules actuate the associated alarm contacts; these can be allocated individually to specific limit values. Hysteresis is set by default to 10 digits but this can be adjusted to any number between 0 and 99. The exceeding of a limit value can also be used to start or stop measured value recording automatically or via macros to initiate other specified actions.

### **Sensor locking**

All sensor data stored in the connector EEPROM can be protected by means of a graduated locking function against undesired access.

## **5.1.2 Measuring operations**

For each transducer up to four measuring channels are available; i.e. it is also possible to evaluate double sensors, individually scaled sensors, and sensors with function channels. You can move forwards or backwards from one measuring channel to the next using the keypad. By default all measuring points are scanned continuously at a measuring rate of 10 mops and the data thus obtained is listed on the display. However, if you want to have the measured values for the selected channel sent to an analog output, it may be an advantage to use semi-continuous mode instead; the output value will then always be refreshed at half the measuring rate set - irrespective of the number of measuring points involved.

### **Measured values**

The measured values of 1 to 20 measuring points can be indicated on the display using a variety of menus, some user-configurable, in three font sizes, and in the form of a bar chart or line graph. Measured values are acquired automatically with auto-zero and self-calibration; however, they can also be corrected and scaled arbitrarily as required. With most sensors a sensor breakage is detected automatically.

### **Analog output and scaling**

By means of analog start and analog end any measuring point can be scaled in such a way that the resulting measuring range covers the full range of the bar chart or line graph or of an analog output (2 V, 10 V or 20 mA). At the analog output the device can output the measured value from any measuring point or a programmed value.

### **Measuring functions**

With some sensors, to achieve optimal measured value acquisition, certain special measuring functions are required. Cold junction compensation is provided for thermocouples; temperature compensation is provided for dynamic pressure, pH, and conductivity probes; and atmospheric pressure compensation is provided for humidity sensors, dynamic pressure sensors, and O<sub>2</sub> sensors. On infrared sensors the parameters for zero-point correction and gain

correction are used as the background temperature and the emissivity factor.

### **Maximum and minimum values**

Each measuring operation acquires and stores the maximum and minimum values with date and time-of-day. These values can then be displayed, printed out, or deleted from memory.

### **Average value**

Measured values can be expressed as a sliding average obtained by continuous automatic smoothing or manually averaged over a certain period or cycle or over a series of individual measuring operations.

## **5.1.3 Process control**

To record the measured values from all connected sensors in digital form measuring point scanning is performed continuously with measured value output according to a time-based process control. This may be per output cycle or, if really rapid results are required, at the measuring rate itself. The measuring operation can be started and stopped by means of the keyboard, the interface, an external trigger signal, the real-time clock, or by a specified limit value being exceeded.

### **Date and time-of-day**

All measuring operations can be accurately logged using the real-time clock with date function or in terms of the pure measuring time. For the purposes of starting / stopping a measuring operation, the start / stop date and time-of-day can be programmed.

### **Cycle**

The cycle can be programmed to any value between 00:00:01 (1 second) and 59:59:59 hh:mm:ss. This function permits cyclic output of measured values to the interfaces or to the memory and provides cyclic calculation of the average value.

### **Print cycle factor**

The print cycle factor can be used to limit data output from particular channels; this may be necessary in order to reduce excessive data flow especially while data is being saved.

### **Averaging over measuring point scans**

The measured values from measuring point scans can be averaged either over the whole measuring duration or over the specified cycle. Function channels are available for the cyclic output and storage of these average values.

### **Measuring rate**

On the ALMEMO® 5690-2M all measuring points are scanned at the measuring rate set (2.5, 10, 50, or 100 measuring operations per second). Recording can be accelerated if all measured values are stored to memory and / or output to the interface at the measuring rate.

### **Measured value memory**

To save measured values there are two alternative methods.

Normally a SD card is used as storage medium. This solution offers a virtually

limitless memory capacity. With the memory card files can be read very quickly via any standard card reader; however, ring memory and selective readout are not possible.

Option S is a 512-KB non-volatile EEPROM, sufficient for up to 100,000 measured values. This memory can be organized and configured in linear or ring form. For output via the interface it is possible to specify a selection according to either the time interval or the number assigned to the measuring operation.

### **Numbering of measuring operations**

By entering a number, single scans or entire series of measuring operations can be identified and selectively read out from the memory.

### **Control outputs**

Via the keypad and interface up to four output relays and analog outputs can be individually addressed.

### **Operation**

All measuring and function values can be displayed in different menus on the dot matrix LCD screen. Three user menus can be individually configured from a range of nearly 50 functions for your specific applications. You can use texts, lines, and blank lines to arrange and format the layout in a style suited to your application. Nine keys (four of them soft keys) can be used to operate the device. This system also allows you to fully program the sensors, the device and the process control.

### **Output**

All data logs, menu functions, saved measured values, and stored program parameters can be output to any peripheral equipment. Interfaces for RS-232, RS-422, and Ethernet are provided by the appropriate interface cables. Measured data can be output in list, column, or table format. Files in table format can be processed directly using any standard spreadsheet software. The print header can be programmed specifically for the company or your application.

### **Networking**

All ALMEMO® devices can be addressed and can be easily networked by simply linking them together via network cable or for longer distances via RS-422 network distributors.

### **Software**

Each ALMEMO® Manual is accompanied by the AMR-Control software package, which can be used to configure the measuring instrument and user menus, to program the sensors, and to read out from the measured value memory. Using the integrated terminal, measuring operations can also be performed online. The software package WIN-Control is provided for the purposes of measured value acquisition via networked devices, for graphical presentation, and for more complex data processing.



## 6. INITIAL COMMISSIONING

**Sensor connection :** Plug in sensor at socket **M0** to **M8** (6c); see Section 8.

**Power supply :** Via mains adapter to socket **DC** (6g); see 7.3, 7.1.

**Switch on :** Press **ON PROG** key (3) on front panel; see 7.5.

Automatic display of last measuring menu see Ch 11.

To activate **MEASURING menus** press

e.g. select **standard display** menu; see 10.1

To activate menu press

**Select measuring point** (see 11.1.1) by means of keys :

To select **max / min values** function(see 10.4) press

Clear max / min values (see 11.1.2)

**Keys**

**<ESC>** or **F4**

**▲** / **▼** ... (**F**)

**▶**

**▲** / **▼** ... (**M**)

**PROG** , **▼** ...

**<CLR>** or **F1**

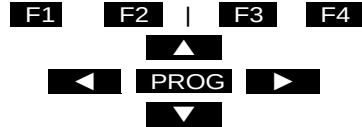
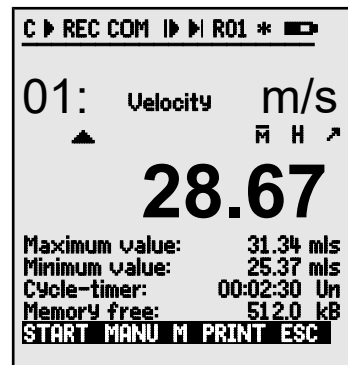
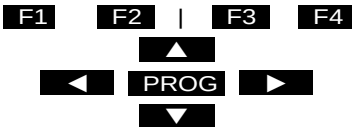

**Output of measured values or memory via interface :**

- Connect peripheral device via data cable to socket **A1** (6f); see Manual 5.2
- On peripheral device set 9600 baud, 8 data bits, 1 stop bit, no parity.

**Once-only output / saving to memory** see 11.3.1

**<MANU>** or **F2**

**Cyclic measuring operation :** **Select cycle timer** :

**PROG** , **▼** ...

Enter cycle (hh:mm:ss); see 10.5

Cycle timer: 00:05:00\$n

Output format list ' ', Columns 'n', Table 't'

**<FORM>** or **F3** ...

Terminate programming

**<ESC>** or **F4**

Start / stop cyclic measuring operation; see 11.3.2

**<START>** , **<STOP>** or **F1**

**Output from memory** to the printer or to the computer :

Select **Memory caPacity free** function by means of :

**PROG** , **▼** ...

Output memory; see 12.2.6

**<PRINT>** or **F3**

Clear the memory; see 12.2.6

**<CMEM>**

## 7. POWER SUPPLY

Power can be supplied to the instrument in any of the following ways :

Mains adapter 12V, 2.5A	ZB1212-NA9
Electr. isol. power supply cable, 10 to 30 VDC, 0.25 A	(ZB3090-UK)
Electr. isol. power supply cable, 10 to 30 VDC, 1.25 A	(ZB3090-UK2)
Rechargeable battery module, NiMH 9.6 V / 1600 mAh	(ES5690-AP)

See product overview, Annex 14 and the following chapters.

### 7.1 Mains operation

To power the device from the mains use the mains adapter provided, 12 V / 2.5A (ZB1212-NA9). The mains adapter must be connected to the DC socket (6g) and locked by twisting to the right.

If necessary the device can also be grounded via the bare socket (6h) (e.g. protective ground connector).

### 7.2 External DC voltage supply

The **DC** socket (6g) can also be used to connect another DC voltage, 10 to 13 V (minimum 200 mA). For this connection use a cable with 2 banana plugs (ZB 5090-EK). If, however, the power supply has to be electrically isolated from the transducers or if a larger input voltage range, 10 to 30 V, is required, then electrically isolated supply cable (ZB 3090-UK) must be used (or ZB 3090-UK2 with the rechargeable battery module). It will then be possible to use the measuring instrument in a 12-volt or 24-volt on-board supply system.

### 7.3 Operation with rechargeable battery

(only with module ES5690-AP)

For mains-independent operation the system must be equipped with module AP with eight NiMH rechargeable batteries (9.6 V / 1600 mAh). At a current consumption of approx. 40 mA this will give an operating time of approx. 40 hours. To prolong the operating time for the purposes of long-term recording the device can be left in SLEEP mode; (see 12.2.5). The operating voltage can be checked in the **Power supply** menu (see 12.7); this gives you a basis for estimating the remaining operating time. When the remaining battery capacity drops to approx. 10%, the  symbol in the status bar of the display will start flashing; as soon as this happens the batteries must be recharged. If the batteries are completely discharged the device will switch off to avoid the risk of critically low discharge. The measured data and time-of-day will, however, be retained; see 7.6. The NiMH rechargeable batteries can in fact be recharged at any time and in any charge status using the intelligent charge circuitry. To charge the batteries the mains adapter, 12V, 2.5A (ZB1212-NA9) must be connected to socket **DC-A** (5a) on the battery module. The "CHARGE" lamp should then light up indicating that the batteries are being recharged. After approx. 3.5

hours the batteries are fully recharged and the LED goes out again. After a certain period the batteries are recharged again; the charge circuitry then switches over to trickle charge. The mains adapter can thus be left permanently connected to the measuring instrument in buffer mode without risk of overcharging the batteries. If you prefer not to recharge the batteries, e.g. to prevent the device from warming up during thermocouple measurement, you can connect the mains unit to the **DC** socket (6g).

## 7.4 Sensor supply

At the terminals + (plus) and – (minus) in the ALMEMO® connector there is, for mains operation, a sensor supply voltage, approx. 12 V, 400 mA, available (self-healing fuse, 500 mA). During battery operation the battery voltage is available, 9 to 11 V. Other voltages (15, or 24 V or references for a potentiometer and strain gauge) can be obtained using special connectors; (see Manual 4.2.5 and 4.2.6).

## 7.5 Switching ON / OFF, Reinitialization

To switch the device **ON** press the **ON-PROC** key (3); the 'ON' lamp should light up as verification.

To switch the device **OFF** press the **ON-PROC** key and hold down for approx. 1 second. After the device is switched off the real-time clock continues to run and all saved values and settings are retained intact; (see 7.6).

If the device behaves abnormally as the result of interference (e.g. electrostatic or mains failure), you are advised try first of all to clear the problem simply by reinitializing, i.e. switching off and then on again.

If this does not help then you can reinitialize the device. To activate **Reset** press **F1** when switching on. To restore all device programming (including times, device designation, user menus, etc.) to the factory default settings press **F4** when switching on. Only the programming of the sensors in the ALMEMO® connectors remains unaffected.

## 7.6 Data buffering

The sensor's programming is stored in the EEPROM on the sensor connector and the device's calibration and programmed parameters are stored in the EEPROM on the instrument itself, both on a fail-safe basis. The memory data is also saved in non-volatile EEPROMs. The date and time-of-day are buffered by a dedicated lithium battery; even when the device is switched off and without batteries this data is retained intact for years.

## 8. CONNECTING THE TRANSDUCERS

Virtually any ALMEMO® sensor can be connected to the input sockets on ALMEMO® modules types (6) and (7). To connect your own existing sensors you simply need the appropriate ALMEMO® connector. Other compact modules are described below.

### 8.1 Transducers

The ALMEMO® Manual includes detailed descriptions of the comprehensive ALMEMO® range of sensors (see Manual Ch 3) and instructions for connecting your own existing sensors to ALMEMO® instruments (see Manual Ch 4). All standard sensors with an ALMEMO® connector usually have the measuring range and units already programmed and can thus be connected to any input socket without further adjustment. A mechanical coding system ensures that sensor and output modules can only be connected to the correct sockets. All ALMEMO® connectors incorporate two snap-lock levers; these snap into position as soon as the connector is inserted into the socket, thus preventing unintended disconnection if the cable is accidentally pulled. To withdraw the connector, both these levers must be pressed in at the sides.

### 8.2 Measuring inputs and additional channels

Measuring circuit board MM-A9 has 9 input sockets (6c) to which initially measuring channels M0 to M8 are allocated. However, ALMEMO® sensors can, if required, provide up to 4 channels with 9 input sockets each so that altogether 36 channels are available. The additional channels can be used in particular for humidity sensors with four measuring variables (temperature / humidity / dew point / mixture ratio) or for function channels. Each sensor can if necessary be programmed with several measuring ranges or scaling settings; and two or three sensors, if pin assignment so permits, can be combined in a single connector (e.g. rH / NTC, mV / V, mA / V, etc.). The additional measuring channel numbers per connector go up in steps of 10 (e.g. the first sensor has channels M0, M10, M20, M30, the second sensor has channels M1, M11, M21, M31 etc.).

#### Device-internal channels

A further innovation on this device is its four additional device-internal channels. The first of these M9 is programmed by default as differential channel M1 – M0. This only applies, however, if there are two sensors with the same units and same decimal point position connected at measuring points M0 and M1. However, all four channels can be programmed with any other function channels (e.g. U-Bat, cold junction compensation, average, volume flow, etc.); (see Manual 6.3.4). The reference channels used are by default Mb1 = M1 and Mb2 = M0 but this can be modified (see Manual 6.3.4).

The advantage of device-internal channels is that when using several sensors for the same application these sensors do not have to be reprogrammed and

can be exchanged without losing the function channels. However, if the whole application operates with just one sensor, then programming on the sensor itself makes more sense.

On the measuring circuit board this gives the following channel assignment:

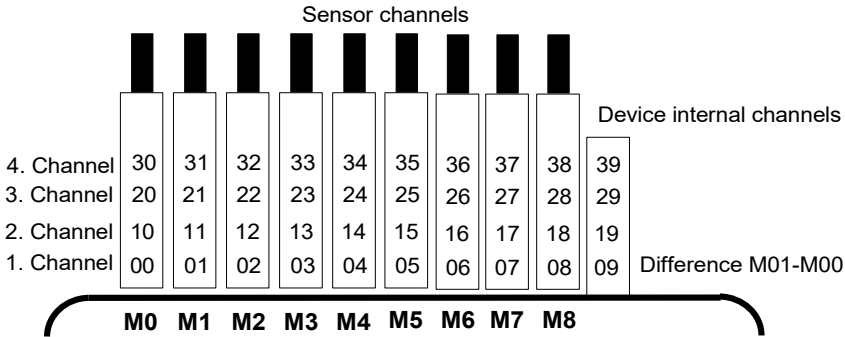

### 8.3 Extending the measuring points

To **extend the measuring points**, up to 9 passive selector switch boards can be used; however, the total number of measuring channels is limited to maximum 100.

The **master measuring circuit board MM-A09 (6)** can also drive up to **9 selector switch boards** with 10 inputs each (7j), and these can in turn be switched by photovoltaic relays. The sensor and channel number of each module can be adapted to individual requirements by configuring the measuring point numbering and thus the channel number of the modules by means of a code switch (7k). This code switch defines the measuring point number of the first measuring point of each module and thus also the channel number of the previous module. This measuring point number must logically be set between 10 and 40 measuring points higher than the previous module and accordingly the channel number of the previous module will be limited to 10 to 40 measuring points. Multi-channel sensors should therefore be collected as far as possible in one module. 99 sensors can only be collected in 10 modules if the channel number of each module is limited to 10, i.e. the measuring point number goes up by 10 each time. The time taken for a measuring point scan increases in proportion to the number of measuring channels.

1. With **selector switch board U-A10 (7)** the number of measuring points is extended each time by 10 electrically isolated ALMEMO® inputs for all ALMEMO® sensors. In the housing each module occupies 2 plug-in slots. For the purposes of thermocouple measurement each module is equipped with 2 cold junction sensors whose value is interpolated for each measuring point. The measuring time involved will affect the total sampling rate.
2. **Selector switch board U-MU (8)** occupies only 1 plug-in slot but it too has 10 inputs led out to a 64-contact socket strip. The sensors are connected

## 8. Connecting the transducers

via a 10-fold connector (ZA 5690-MU) each with four screw terminals A, B, C, D, in the same way as any standard ALMEMO® connector; (see Manual 4.1). Sensors requiring a power supply or an ALMEMO® connector with special interface circuitry (e.g. humidity sensors, rotating vanes, etc.) cannot be connected in this way. The new connector ZA 5690-MU with a larger EEPROM now permits 4 channels per sensor, i.e. 40 channels altogether; on the old connector ZA 5590-MU there are only 10 channels available. Measuring point numbering is as described above, namely by means of a code switch internally on the board. For this purpose the module must be withdrawn and the number on the switch multiplied by 10 (4 = measuring point 40). All sensors can be programmed individually but their programming data is all saved together in a common EEPROM located in the connector. A cold junction sensor is also provided for thermocouples. Two limit value relays, operating separately for maximum and minimum, can be contacted in the connector; these can only be used with an appropriate selector switch board option.

3. **Selector switch board U-TH** (9) has 10 inputs for thermocouples with a thermal connector. The sensor data is saved to an EEPROM on the board; automatic sensor recognition is therefore not possible. Measuring point numbering is by means of the code switch internally on the board (see above). This module occupies only 1 plug-in slot but if arranged in series one dummy panel must be inserted between in order to operate the connector.

4. **Selector switch board U-KS** (10) also has 10 inputs; these are led directly onto two 20-contact plug connectors with terminals. Sensors can be connected via terminals A, B, C, D, with the usual wiring arrangement. (s. Man. 4.1) In order to feed in the wires the outside connectors must be opened by inserting a narrow screwdriver in the inside holes. The sensor data is saved to an EEPROM on the board; automatic sensor recognition is therefore not possible. Measuring point numbering is by means of the code switch internally on the board (see above). This module, similarly, occupies 1 plug-in slot only.

A	B	0
C	D	
A	B	1
C	D	
A	B	2
C	D	
A	B	3
C	D	
A	B	4
C	D	

Or alternatively the **UKSI cards** are available with shunts for 20-mA signals (terminals A(-) and B(+), 'mA' or '%') or the **UKSU cards** with dividers for 10-V signals (terminals A(-) and C(+), 'mV'). This module is only suitable for thermocouples if these are connected with copper wires via an isothermal block with integrated cold junction sensors; (see Manual 6.7.3).

### 8.4 Potential separation

When organizing a properly functioning measuring setup it is very important to ensure that no equalizing current can flow between sensors, power supply, and peripherals. This will be the case so long as all points lie at the same potential or unequal potentials are electrically isolated.

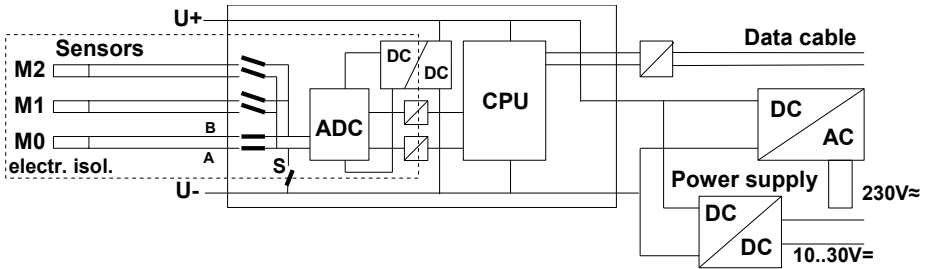

The analog inputs are electrically isolated from one another by means photo-voltaic relays. A new feature on this device is the additional separation of the measuring inputs from CPU and power supply. Between all inputs and outputs (even the analog output cables which are not electrically isolated) the maximum potential difference permitted is 50 V. The voltage at the measuring inputs themselves must not exceed 12 V (between B, C, D, and A).

**However, some components are not electrically isolated**, namely all sensors connected to the same internal power supply  $\pm U$  or combined sensors within one connector. For these sensors the electrical isolation may have to be disabled by means of relay S (see above) or by wire jumper; some inputs would otherwise be left without reference potential. The relay is set automatically by element flag 5 'ISO OFF' the first time it is connected; (see Manual 6.10.3). However, with certain connectors (especially divider connectors without power supply) element flag 5 should be checked and if necessary corrected. These sensors must themselves be isolated or the device must be operated with an electrically isolated power supply (mains adapter or connecting cable ZA3690-UK with DC/DC converter).

Data and trigger cables are also isolated by means of optocouplers.

## 9. RELAY TRIGGER ANALOG MODULE

The universal trigger output interface specially provided for ALMEMO® 5690 systems is relay trigger analog module ES 5690-RTA5 with up to 10 interface elements (4 semiconductor relays and 2 trigger inputs as standard but optionally up to 10 semiconductor relays or 10 electrically isolated analog outputs).

Up to maximum 7 modules can be simply plugged into a free slot, preferably after the measuring inputs; they will be detected and recognized automatically as soon as the system is powered up. All 10 interface elements of each module can in the 'Output modules' menu be individually selected and configured as ports P0 to P9. (see 12.6.2)

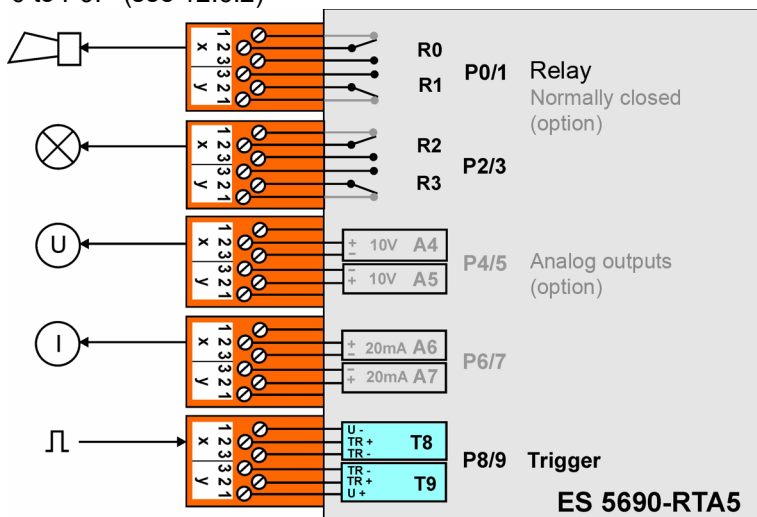

### 9.1 Power supply

The adapter is supplied with a voltage of 9 to 12 VDC via the system itself. In the standard version the maximum requirement is 20 mA. It is only with optional analog outputs, in particular with electric current outputs, that the maximum supply current per module must be observed. (see 9.3)

### 9.2 Interface elements and options

Sockets P0/1 and P2/3 are fitted as standard with four semiconductor relays, normally open type; socket P8/9 is fitted as standard with two trigger inputs. Option OA 8006-OH2 provides each relay pair with two additional semiconductor relays, normally closed type.

Option OA 8006-SH2 can be used in each case to retrofit two further relays (up to maximum 10), including ALMEMO® clamp connectors.

Option OA 8006-R02 can be used to equip the sockets - initially P4/5 and P6/7 but subsequently also all others - with analog outputs 0 to 10 V or 0 to 20 mA



electrically isolated, including ALMEMO® clamp connectors.

### 9.2.1 Relays

The output relays are driven by means of interface commands or in the event of alarm automatically by the system. (see Manual, 6.10.10) The function of each relay can be freely set by configuration. (see 12.6.2) The assignment of a limit value to a relay can be programmed in the sensor by the device. (see 12.4.3) Whenever a relay is activated a short acoustic alarm is sounded. The way in which these relays are driven can be configured as inverted so that they pick up in normal conditions and drop out in the event of alarm or power failure.

In the following cases it is advisable to connect a mains voltage changeover relay downstream (e.g. Phoenix PLC-RSC-24DC/21, 250V 6A).

- ▶ Current or voltage capacity greater than 50 V, 0.5 A
- ▶ For separating the mains voltage side
- ▶ For the realization of an alarm failure of the control side

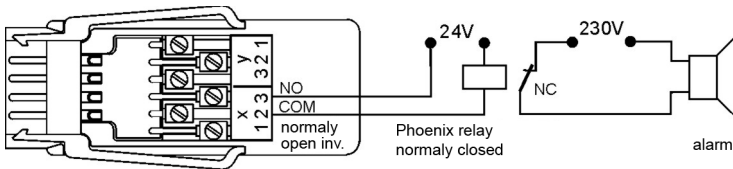

### 9.2.2 Trigger inputs

Trigger inputs P8 and P9 can be driven via optocouplers on the basis of voltage levels (4 to 30 V). When using floating switch contacts the optocouplers must be appropriately wired with supply U+ and U-. (see diagram)

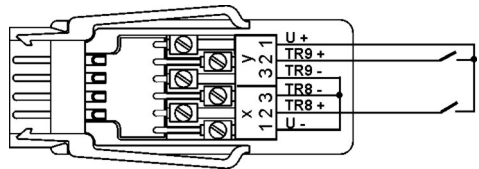

The trigger function (as standard to start or stop a measuring operation) can also be freely configured. (see 12.6.2)

### 9.2.3 Analog outputs

In various options the module can also be fitted with electrically isolated analog outputs, offering the following signals.

Option	Output signal	Gain
OA 8006-R02	0.000 to +10.000 V	0.5 mV / digit
	or 0.000 to +20.000 mA	1 $\mu$ A / digit

The output value normally corresponds to the measured value for the selected measuring point. Or alternatively the analog value can be specified as control variable via the interface. (see Manual, 6.10.7) The output signal can in each

## 9. Relay trigger analog module

case be programmed as standard output 0 to 10 V, 0 to 20 mA, 4 to 20 mA for any partial measuring ranges. (see 12.4.4, 12.6.3)

### 9.2.4 Connecting peripheral equipment

Peripherals can be connected via the supplied ALMEMO® screw connectors according to the following arrangements.

Terminals	P0/1 Relay	P2/3 Relay	P4/5 Analog (opt.)	P6/7 Analog (opt.)	P8/9 Trigger
y1	R1 n. closed (opt.)	R3 n. closed (opt.)	(opt.)	(opt.)	U+
y2	R1 Common	R3 Common	AO5 +	AO7 +	TR9+
y3	R1 n. open (opt.)	R3 n. open (opt.)	AO5 -	AO7 -	TR9 -
x3	R0 n. open (opt.)	R2 n. open (opt.)	AO4 -	AO6 -	TR8 -
x2	R0 Common	R2 Common	AO4 +	AO6 +	TR8+
x1	R0 n. closed (opt.)	R2 n. closed (opt.)			U -

### 9.2.5 Putting into service

1. The relay module should be plugged into a free slot in the ALMEMO® system; the integrated interface elements are then available as port P30 to P39.
2. The peripheral equipment should be connected to the clamp connector and plugged in on the relay module at the appropriate port sockets. see 9.2.4
4. All the programming functions can be performed via the device keypad in the "Output modules" menu (see 12.6.2) or using the AMR-Control software or via terminal commands. (see Manual, 6.10.9.2 and 6.10.10)

## 9.3 Technical data

Relays	Semiconductor relay 1 ohm, Load capacity 50V, 0.5A
Trigger inputs	Optocoupler 4 to 30 V, Input current 2 mA
Analog outputs	electrically isolated, optionally
OA 8006-R02	0.00 to +10.0 V, 0.5 mV / digit, Load >100 kΩ 0.0 to +20.0 mA, 1 μA / digit, Load <500 Ω
Accuracy	±0.1% of final value
Temperature drift	10 ppm / K
Time constant	100 μs
Power supply	9 to 12 VDC from the measuring instrument
Current consumption	Standard approx. 10 to 20 mA
	For each 2 analog outputs appr. 15 mA + 1.75 x I <sub>OUT</sub>
Housing	19" plug-in device 8 DU

## 10. DISPLAY AND KEYPAD

### 10.1 Display and menu selection

In the graphics display (1) three selection menus are available :

#### 1. Measuring menus

There are 9 measuring menus; these list the measuring and function values in various ways. There are 3 user menus (U1, U2, and U3); these can be freely configured by the user.

#### 2. Programming menus

Here you can program the settings needed on the device and on the sensors and the process control for the data logger.

#### 3. Wizard menus

These will help when it comes to programming and measuring for special applications.

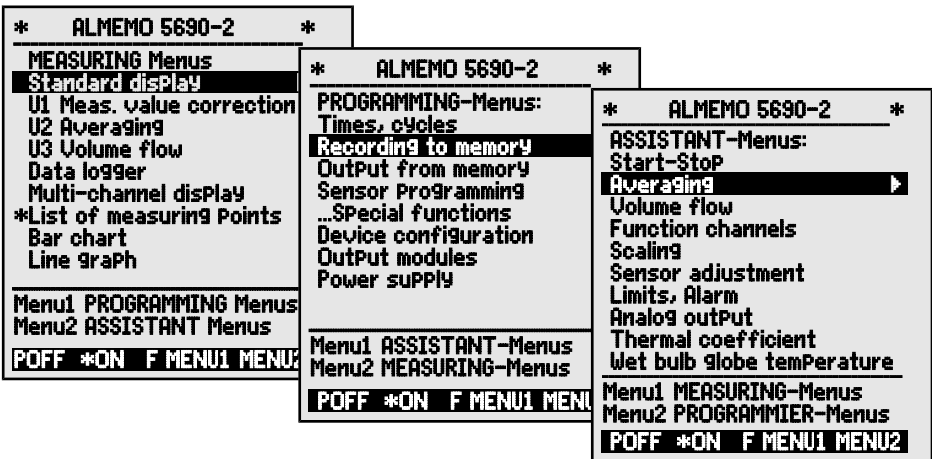

Display menu selection by means of

To select desired menu selection press

**<ESC>**  
**<MENU1>** or **<MENU2>**

Display backlighting can be switched on in 3 levels (see 12.5.5)

**< \* ON >** ...

To switch off the device press

**<P-OFF>** or **ON** (press and hold down)

To select the menu press

**▲** or **▼** ...

To activate the selected menu press

**▶** or **PROG**

To return to the measuring menu last used press

**◀**

To return to the programming menu last used press press

**◀** again

To return to menu selection press

**<ESC>**



You can program the device designation in the header line (see 12.5.1) and the titles of the user menus (see 11.7).

## 10.2 Status symbols in the display and status LEDs

### Checking the device status

	Status bar	LEDs
Continuous measuring point scan	C	
Measuring stopped or started	or ▶	START
Measuring point scan started with data saving	RECREC	
Measuring point scan started with output to interface	COM	COM
Start time or end time of meas. operation programmed	▶ or ▶	
Status of relay (external output module) off / on	R-- or R01	
Keypad operation restricted by locking	LOCKED	
Display backlighting switched on or pause	* or *	
Battery charge status: full, half, empty	▶, ◻, ◻	

### Symbols indicating the measured value status (see above)

No sensor, measuring point deactivated	'-----'
Measured value modified with sensor correction or scaling	↗
Averaging in progress	M̄ AVG
Output function Diff, Hi, Lo, M(t), Alarm (see 12.4.5):	D, H, L, M, A
Compensation C: T Temp., P Press. (atm.), . Continuous	CT. P. (. flashes)
Limit value exceeded, maximum or minimum	▲ or ▼ flashes
Outside of measuring range : Maximum value	◻ flashes ALARM
Outside of measuring range : Minimum value	U flashes ALARM
Sensor breakage / voltage low : Display ' - . - . - '	B / L flashes ALARM

## 10.3 Function keys

The function of keys **F1** to **F4** (3) can be different in each of the various menus. The function is indicated as an abbreviation in the bottom line of the display (soft keys). In the instructions and documentation these soft key abbreviations are shown in angle brackets, e.g. **<START>**.

Various status symbols are displayed next to the measured value; (see below).

In the **standard display** (on the right) the following keys are available.

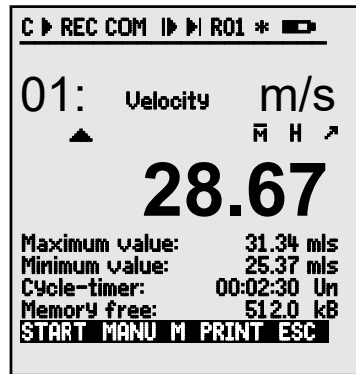

Measuring point selection using the cursor keys (3) (M in middle) ▲ o. ▼ ...

**Start** a cyclic measuring operation

Stop a cyclic measuring operation

Once-only manual output / saving of all measured values

Output menu functions via the interface

**Return to menu selection**

<START>	or	F1
<STOP>	or	F1
<MANU>	or	F2
<PRINT>	or	F3
< ESC >	or	F4

## 10.4 Function selection

Each menu comprises a number of functions; these may have to be activated or programmed during operation.

**Help window** for selecting functions

To set measured value to zero, Press key: ZERO  
To adjust sensor in zero Point (slope) Press key: ADJ

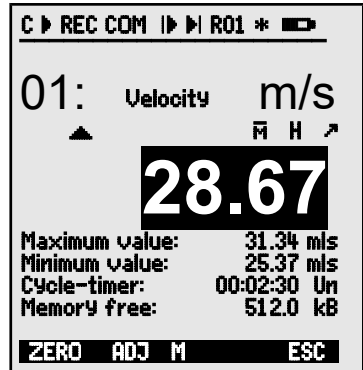

**Selection of functions** The first changeable parameter is highlighted in inverse font on a black background

A character should appear in middle of the soft-key bar as verification

Jump to next function

Depending on function the keys **F1** to **F3**

are assigned the desired meaning, e.g. Clear maximum <CLR>

Set measured value to zero, Adjust measured value <ZERO> / <ADJ>, **PROG**

Output memory <PRINT>

Clear memory <CMEM>

## 10.5 Data input

When a programmable parameter is selected (see 10.4) you can enter a value or clear the current value.

**Clearing programmable values**

To program press

You should now be in **programming mode** of soft key bar;

the cursor flashes below the first input position

**Increment** the selected digit with

**Decrement** the selected digit with

**Change arithmetic sign** of numeric values

**Select next position**

the cursor flashes below the second digit

**Jump back to previous position**

**Each position** is programmed like the first

**Terminate data input** **PROG**

**Cancel programming** <ESC>

<CLR>

**PROG**

**P** should appear in middle

Cycle timer: 00:00:00

▲ ...

▼ ...

< +/- >



▶

Cycle timer: 00:00:00

◀

▲ / ▼ ..., ▶

## 11. MEASURING WITH THE MEASURING MENUS

When the device is switched on for the first time it displays the menu Measuring points list (see 11.5.3). This provides a clear overview of the whole measuring system. Here you can check whether the date and time-of-day are correctly set. If they are not you can enter the correct values now; (see 10.4 and 10.5). You are also shown a continuous display of the measured values for all connected sensors and measuring channels. You can also, by means of cursor keys  or , even assign other additional functions such as designation, range, maximum value, and limit values. If you program the cycle timer (see 11.3.2), you can, by pressing <START> , start the first measuring operation and record measured values cyclically. If a printer or a terminal is connected all values can also be output online. Having selected the channels you can then program the measuring points. To select other measured value menus press <ESC>.

```
C ▶ REC COM |▶▶ R01 *■▶
-----
Meas.Points list: Comment
Time: 12:34:56 Date:01.01.04
Cycle-timer: 00:00:30 mS
00: 23.12 °C TemPeratur
01: 11.37 m/s Velocity
02: 123.4 mU U2.4
10: 53.6 %H r.Humidity
20: 15.2 °C Dew Point
30: 11.2 g/k a.Humidity

START MANU F PRINT ESC
```

### Menu selection

To ensure that measured values and the associated functional values are acquired and displayed in your application in the clearest possible way the 5690-2M system incorporates a series of preconfigured measuring menus. These can be selected from the range of **measuring menus**; they differ from one another in the number of measuring points (1 to 20), in the font size used to display measured values (4, 8, 12 mm), in the choice of bar chart or line graph, and in the grouping of functions. If these preconfigured menus do not completely meet your requirements, you can assemble your own 3 user menus (U1, U2, U3) from a range of over 50 functions; (see 11.7).

To activate menu selection press

To select a menu press

To activate the selected menu press

The most important functions for controlling the measuring sequence are already included in and can also be directly programmed in the measuring menus. The system also provides special **PROGRAMMING menu** for the purposes of programming the sensors and the device and **ASSISTANT Menu** for particular functions.

These can be selected by pressing the keys

<MENU1> or <MENU2> .

```
* ALMEMO 5690-2 *
-----
MEASURING-Menus:
Standard display ▶
U1 Meas. value correction
U2 Averaging
U3 Volume flow
Data logger
Multi channel display
*List of measuring Points
Bar charts
Line diagram

Menu1 PROGRAMMING-Menus
Menu2 ASSISTANT-Menus

POFF *ON F MENU1 MENU2
```

```
<ESC>
▲ or ▼ ...
▶ or ◀ PROG
```

## 11.1 Measuring with a measuring point

### Standard display

The menu **Standard display** shows a measuring point in the largest size with measuring point, designation, and units. Symbols indicate the measured value status; (see 10.2). The maximum and minimum functions are described in Section 11.1.2, the cycle timer in Section 11.3.2. and saving to memory in Section 11.3.3.

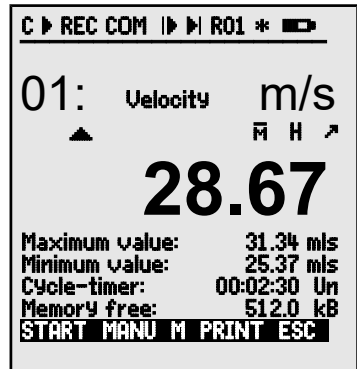

### 11.1.1 Selecting a measuring point

By pressing you can select one after the other all active measuring points and have the current measured value displayed for each (**M** in the middle of the soft-key bar). By pressing you can jump back to the previous channel. When a particular measuring channel is selected the associated input channel is also selected at the same time.

To increment the measuring channel press .

To decrement the measuring channel press .

### 11.1.2 Peak value memory with date and time-of-day

The highest and lowest values are identified from the acquired measured values for each measuring point and continuously updated to memory together with date and time-of-day. To display these values use the functions listed below; to output them use the function channels; (see 12.3.10).

Using the AMR-Control software the Monitoring menu including Max / Min times (as shown on the right) can be loaded and easily configured as a user menu (see 11.7).

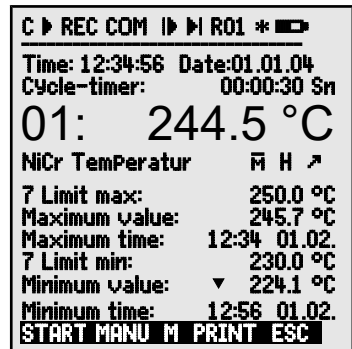

Function maximum value

Function minimum value

Function Date and time-of-day of maximum value

Function Date and time-of-day of minimum value

To clear memory select the function (see 10.4):

To clear each individual value press

To clear maximum, minimum, and average values

for all channels press **<CLRA>**

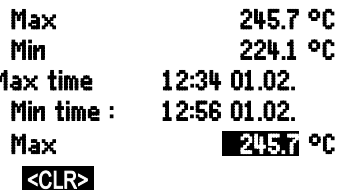

## 11. Measuring with the measuring menus

As soon as you clear the memory, the current measured value will appear (because measuring is continuous). Each time a measuring operation starts, if the device has been so configured, the peak values will be cleared ; (for default setting see 12.5.8). Cyclic clearing can be activated by programming the averaging mode CYCL (see 11.4.7).

### 11.2 Measured value correction and compensation

To achieve maximum measuring accuracy the zero-point of the sensors can be corrected in all menus at the touch of a button. More correction functions are provided in the user menu **U1 Measured value correction** (selection, see 10.1). By entering a setpoint the correction value will be automatically calculated and stored in the sensor connector. For sensors affected by ambient temperature or atmospheric pressure the appropriate compensation can then be provided.

```
C ▶ REC COM ▶ ▶ R01 * ◀
01: 25.45 m/s
L840 Pitot tube ↗
Locking mode: 3
SetPoint: 25.0 m/s
5 Base: -----
5 Factor: 0.6891
4 Zero corr: 0.7 m/s
4 SloPe corr: -----
Temp. comp: 245.7 °C
Air. Pressure: 1027 mb
START MANU M PRINT ESC
```

#### 11.2.1 Set measured value to zero

One very useful function is to zero the measured value at certain locations or at certain times as a reference value in order then to observe subsequent deviation. Having selected the measured values function in any menu (see 10.4) you will be shown a help window listing all the possibilities for measured value correction. If you press **<ZERO>** , **PROG** the displayed measured value will be saved as **base value** and thus set to zero.

Function **Select measured value**

Function **Zero-set measured value**

To execute press

Measured value

Base value

If the function is locked (see 12.3.4) the base value is not saved on the connector but only **temporarily** to RAM where it is retained until the device is next switched off. This function can be blocked by using locking level 6.

00: 23.4 °C

<ZERO>

PROG

00: 00.0 °C ↗

base value 23.4 °C

```
Sensor ist locked
-Zero setting temporarily
Press key: PROG
```

```
-To cancel Press key: ESC
```



Whenever the display indicates a deviation from the base value (instead of the actual measured value) the symbol ↗ will appear.

To obtain the actual measured value again the base value must be cleared; (see 12.3.6).



### 11.2.2 Zero-point adjustment

Many types of sensor need to be adjusted at least once or at regular intervals to compensate for various instabilities. This can be done with the above-mentioned 'Set measured value to zero' - but also with the special **zero-point adjustment** which does not influence scaling. If this function is used, the zero-point error is not stored as base value but as **zero-point correction**; (see 12.3.7).

Function **Select measured value**

Function **Zero-point adjustment** by pressing

To execute press

Measured value

Zero-point

If the function is locked at level 3 or above (see 12.3.4) a help box states that it can only be unlocked temporarily for adjustment purposes; this ensures that the correction values are remain permanently stored on the connector.

For adjustment temporarily unlock by pressing

00: 01.2 °C

<ADJ>

PROG

00: 00.0 °C

zero-Point

↗

01.2°C

Sensor is locked.  
To adjust temporarily unlock  
by Pressing FREE

To cancel Press ESC

<FREE>



If a base value has been programmed, the measured value indicated after adjustment is not zero but the negative base value.



In the case of **dynamic pressure probes** the zero-point error is always written to the calibration offset temporarily (i.e. until you switch off) even if the channel is locked.

### 11.2.3 Sensor adjustment for chemical sensors and probes

With the following sensors in the measured value function press **<ADJ>** (see 11.2.2) to automatically reach the wizard menu **sensor adjustment** for **two-point adjustment** of the **zero-point** and **gain**. The appropriate calibration set-points should already be entered but these can also be modified.

Probe	Type	Zero point	Gain
pH probe	ZA 9610-AKY:	7.00	4.00 pH or 10.00 pH
Conductivity	FY A641-LF:	0.0	2.77mS/cm
	FY A641-LF2:	0.0	147.0µS/cm
	FY A641-LF3:	0.0	111.8mS/cm
O <sub>2</sub> saturation	FY A640-O2:	0	101 %

Temperature and atmospheric pressure can also be entered here if necessary for compensation purposes (see 11.2.5, 11.2.6).

**SENSOR ADJUSTMENT**

Select measuring channel:  
01: 7.23 PH PH-Wert

Temp.Compensation: 25.0 °C

Air Pressure 1013. mb

Zero Point:  
SetPoint 1: 7.00 PH

01: 7.00 PH PH-Wert

Slope:  
SetPoint 2: 10.00 PH

01: 10.00 PH PH-Wert

Slope error: -10.8 %

CLEAR ADJ M ESC

## 1. Setting up a means of calibration for the zero point:

Function **Select setpoint 1** SetPoint 1: 07.00 PH

**Zero-point adjustment** by pressing

<ADJ>

Adjustment value is retained

00: 07.00 PH ↗



In the case of pH probes you can by pressing <CLEAR> restore the default values, base value 7.00 and gain -0.1689.

## 2. Setting up a means of calibration for the slope:

Function **Select setpoint 2**

SetPoint 2 10.00 PH

**Gain adjustment** by pressing

<ADJ>

Adjustment value is retained

00: 10.00 PH ↗

Gain shows approx.

Gain : -0.1689

The **gain error** shows the deviation from the

rated value and thus the status of the probe. Gain error 9 %



If sensors are locked they can be temporarily unlocked by pressing <FREE>.

## 11.2.4 Two-point adjustment with setpoint entry

In menu **U1 Measured value correction** two-point adjustment can also be performed for other sensors. In addition to zero-point adjustment gain is also corrected in the **SetPoint** function by means of a second measuring point. The correction factor is calculated automatically at the touch of a button and stored as factor on the sensor connector.

### 1. Zero-point adjustment

Put sensor in its **zero status**

(icy water, unpressurized, etc.)

To set measured value to zero (see 11.2.2) press <ZERO> / <ADJ> , PROG

### 2. Final value correction

Adjust sensor in a defined **setpoint**

00: 098.7 °C

(boiling water, known weight, etc.)

With **ALMEMO force transducers**

activate calibration resistance (see Man. 3.6.2)

<ON> or <OFF>

**Enter setpoint** in function 'Setpoint'

SetPoint : 100.0 °C

Adjust measured value in function 'Setpoint' :

<ADJ>

The measured value shown should then be the setpoint. 00: 100.0 °C



If the sensor is locked at level 4 the correction factor is programmed as 'Factor'; if the sensor is locked at level <= 3 or temporarily unlocked by pressing <FREE> , the correction factor is programmed as gain correction (see 12.3.7).

### 11.2.5 Temperature compensation

Sensors whose measured values depend heavily on the temperature of the measuring medium usually incorporate their own temperature sensor and perform temperature compensation automatically; (see Section 12.3.9 Measuring range list 'with TC'). However, dynamic pressure probes and pH probes are also available without their own temperature sensor. If the temperature of the medium deviates from 25°C the following measuring errors must be considered

e.g. Error per 10 °C:	Compensation range	Sensor
Dynamic pressure approx. 1.6 %	-50 to 700 °C	NiCr-Ni
pH probe approx. 3.3 %	0 to 100 °C	NTC or Pt100

Compensation at constant temperature can be activated via function **Temp comp.** e.g. in the menu **Measured value correction** :

Enter the compensation temperature in function **Temp.comP: CT 31.2 °C**

Continuous temperature compensation with external temperature sensors can be activated either via the reference channel of the sensor to be compensated or by configuring any temperature sensor as reference sensor with a '\*T' in the designation; (see 10.3.2) :

While the temperature is being measured, point T flashes. **Temp.comP. CT 23.5 °C**



Automatic temperature compensation can be switched off by programming the reference channel for the measuring point to itself.

### 11.2.6 Atmospheric pressure compensation

Some measured variables depend on the ambient atmospheric pressure (see Section 12.3.9 Measuring range list 'with PC') with the effect that large deviations from normal pressure (1013 mbar) may lead to measuring errors.

e.g. error per 100 mbar		Compensation range
Rel. humidity psychrometer	approx. 2 %	500 to 1500 mbar
Mixture ratio, capacitive	approx. 10 %	Vapor pressure VP up to 8 bar
Dynamic pressure	approx. 5 %	800 to 1250 mbar (error < 2 %)
O2 saturation	approx. 10 %	500 to 1500 mbar

It is advisable therefore, especially when taking measurements at appreciable heights above sea level to take due account of the atmospheric pressure (approx. -11 mbar / 100 m above mean sea level, MSL). This can be programmed (see 12.5.6) or it can be measured using a suitable sensor (reference sensor with designation '\*P', see Manual 6.7.2).

The function **Atmospheric Pressure** can be integrated into any user menu or be set in the standard menu **Device Configuration** .

Enter atm. pressure in the function **Atm. pressure** **AtmosPh. Pressure CP 1013 mbar**

The atmospheric pressure is set to 1013 mbar with each reset. It can be set to the current value at any time using the usual data input process; (see 10.5). If atmospheric pressure is being used for compensation in a measuring menu the symbol 'CP' is displayed; if atmospheric pressure is itself being measured the measured value is displayed and a dot flashes after 'CP'.



Please note that as soon as a reference sensor is disconnected normal pressure, 1013 mbar, is used.

### 11.2.7 Cold junction compensation

Cold junction compensation (CJ) for thermocouples is normally performed completely automatically. On this device, with 9 sockets, to ensure the highest possible degree of accuracy - even in difficult thermal conditions (e.g. thermal irradiation) - the socket temperatures are acquired by means of two precision NTC sensors in measuring sockets M0 and M8 and then calculated by linear interpolation. The mean cold junction temperature is displayed as an operating parameter in the device configuration (see 12.5.8). This can if necessary be incorporated in measured data acquisition as device temperature with function channel 'CJ' (see 12.3.10).

Instead of this form of cold junction temperature measurement it is also possible to use an external measuring sensor (Pt100 or NTC) in an isothermal block (see Manual 6.7.3); this must be positioned upstream from the thermocouples and '\*J' must have been programmed in the first two positions in the designation (see 12.3.2). In this mode the device is switched over automatically to 'continuous measuring point scan'.

For especially exacting requirements (e.g. for thermocouples for which there is no connector with thermo-contacts or for large temperature differences caused by thermal irradiation) special connectors are available, each with its own integrated temperature sensor (ZA-9400-FSx) for cold junction compensation. These can be used for all thermocouple types; however, they require two measuring channels. Having "#J" programmed in the first two positions in the designation for the thermocouple ensures that the temperature sensor integrated in the connector is indeed used for cold junction compensation.

### 11.3 Measuring point scan and output

Measuring point scanning is used to acquire measured values from all measuring points either manually at certain times or cyclically over a specified period; these values can be saved on the computer or output to the printer; (see Manual 6.5).

This can be performed e.g. in the **Data logger** menu :

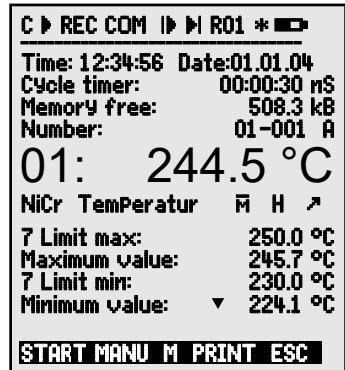

#### 11.3.1 Once-only output / saving of all measuring points

Once-only manual measuring point scans for acquiring the current measured values from all active measuring points (see Manual 6.5.1.1) can be initiated by pressing **<MANU>**. If the time-of-day is required in the display, it must first be set (see 12.1.1). The output format can be set in the **Cycle timer** function (see 11.3.2).

##### Once-only manual measuring point scan :

**<MANU>**

In the **status bar** as verification the following symbols will briefly be displayed :

The start arrow will light up briefly and then go out again

▶

Lights up when data is being output via the interface

'COM'

Lights up when measured values are being saved (see 12.1.2)

'REC'

Each time the key is pressed again after this the measured values will be processed with the associated measuring time.

#### 11.3.2 Cyclic output / saving of all measuring points

For cyclic recording and output of measured values (see Manual 6.5.1.2) the cycle and the output format must be programmed accordingly. The measuring operation can be started by pressing **<START>** and stopped by pressing **<STOP>**. Each time a measuring operation starts, if the device has been so configured, the maximum, minimum, and average values of all measuring points will be cleared (for default setting see 12.5.8).

So long as no measuring operation has been started the **Cycle timer function** displays the cycle. Once the function has been selected (see 10.4) the cycle can be entered directly (see 10.5). Once started the timer counts down to the next cycle.

Function **Cycle timer** :

Cycle timer 00:02:00 S

Cycle (hh:mm:ss), Saving ON, List format

## 11. Measuring with the measuring menus

The quickest way to set the required output format is by pressing **<FORM>**; (for print layouts see Manual 6.6.1).

Change format

**<FORM>**

Format, adjacent columns 'n':

**Cycle timer 00:02:00 Sn**

Change format

**<FORM>**

Format, table 't':

**Cycle timer: 00:02:00St**

**To start cyclic measuring point scan press **<START>****

The following symbols will be displayed as verification in the **status bar** **will be displayed continuously**, i.e. so long as the measuring operation is running.

The start arrow lights up

**▶**

Lights up when data is being output via the interface

**'COM'**

Lights up when measured values are being saved (see 12.1.2)

**'REC'**

**To stop cyclic measuring point scan press **<STOP>**** **'||'**

### 11.3.3 Memory space, memory output, clearing the memory

When measured values are being recorded the **Memory caPacity free** function continuously displays the memory capacity still available. Selecting this function enables two soft keys, one for direct memory output and one for memory clearing. The output format is as set in the cycle (see 11.3.2 and 12.1.2)

Function **Memory free** e.g.

**Memory free 0378.4 KB**

To output the memory (see 12.2.6):

**<PRINT>**

To clear the memory

**<CMEM>**

### 11.3.4 Output menu functions

Each measured value menu, together with all its displayed functions, can be output via the interface to a printer or computer; (for connection of peripheral devices, see Manual 5.2). If you have selected the standard display, pressing the key **<PRINT>** will initiate printout of the following protocol.

Print measured value menu

**<PRINT>**

Measuring point, measured value, designation 01: +0023.5 °C Temperature

°C

MAXIMUM VALUE : 01:+0020.0

°C

MINIMUM VALUE : 01:-0010.0

PRINT TIMER: 00:01:23

Memory capacity - total / free in KB

MEMORY: S0512.1 F0324.4 A

The protocols for individual functions is listed in Section 6.6.1.

### 11.3.5 Displaying measured values as a line graph

In the **Line graph** menu the measured value of the selected channel is displayed, as soon as a measuring operation starts, as a line graph with 100 x 200 pixels. The curve is continuously updated from right to left according to the time resolution defined by the **cycle**; each scan affects one pixel. The resulting time data for the whole t axis is displayed as (days) hours : minutes in the bottom right corner. In the top right corner the time-of-day is displayed. The curve is updated throughout the active measuring operation - even if the user leaves the menu (so long as the selected measuring point is not changed).

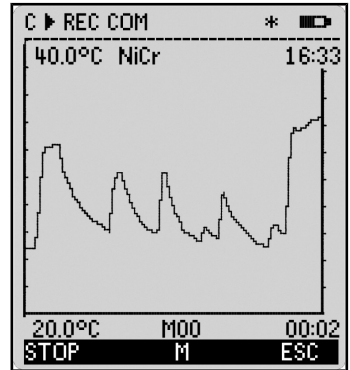

Limit values, if activated, are displayed as dotted lines.

To set the display for the y axis the functions **Analog start** and **Analog end** in the **Special functions** menu should be used; (see 12.4.4). These functions can also be entered directly on the axis, pressing **PROG**.

#### Displaying a measured value as line graph

In the **Times - cycles** menu enter the cycle

Time axis 120 x 5s = 10 mins

To select a measuring channel press

To scale the y axis press

Analog end at top

To modify value (see 10.5) press

...

Analog start at bottom, ditto

Stop input

Start measuring operation

Stop measuring operation

Cycle: 00:00:05

00:10

▲ or ▼ ...

PROG 40.0 %H

PROG , ▲ / ▼ ..., ►

▼ 20.0 %H

<ESC>

<START> ►

<STOP> ||



During the measuring operation channel switching is blocked. Each time a measuring operation starts and each time the channel is switched the line graph will be cleared.

## 11.4 Averaging

The **average value** for a measured value is needed for various applications e.g. smoothing a widely fluctuating measured value (wind, pressure etc.).

Average flow velocity in a ventilation channel

Hourly or daily average values of weather data (temperature, wind etc.)

Also for consumption values (current, water, gas, etc.)

The average value  $\bar{M}$  for a measured variable is obtained by totalizing a whole series of measured values ( $M_i$ ) and dividing by the number of measured values (N).

$$\text{Average value } \bar{M} = \left( \sum_i M_i \right) / N$$

The ALMEMO 5690-2M offers several different averaging modes.

These include measured value smoothing for the selected channel with a sliding averaging window, averaging over individual measuring operations selected by place or time (also networked measuring as per VDE), averaging over the full measuring time, over cycles, or over specified measuring points.

For all these modes you can call up a special wizard menu **Averaging** to help you enter the necessary parameters with help windows that will teach you how best to proceed.

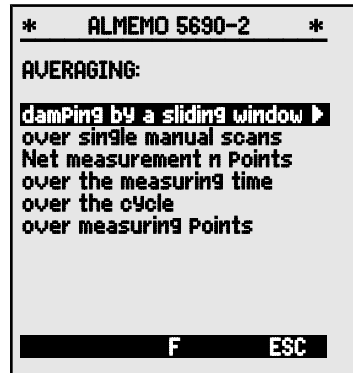

### Measuring menu **Average value** :

Most averaging functions can also be performed directly in a measuring menu, e.g. 'User menu' **U2 Average value**. Help windows explaining the various averaging modes are available in the programming stage, e.g.

**Averaging : CONT**  
 over the whole measuring operation by Pressing START / STOP over individual manual measuring operations by Pressing MANU

To calculate volume flow from the average velocity and the cross-section of a flow conduit you can use either the 'User measuring menu' the **Volume flow wizard**.

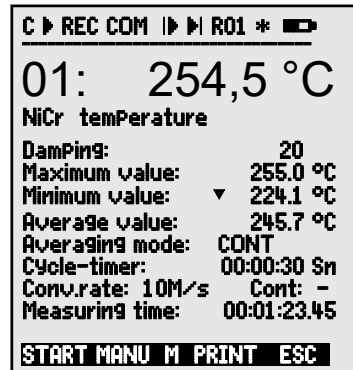

**U3 Volume flow** (see 11.4.9) or



### 11.4.1 Smoothing out meas. val. by means of a sliding average

The first method for averaging applies exclusively to the measured value of the displayed channel; it is used to smooth measured values of an unstable or strongly fluctuating nature, e.g. especially turbulent flows, by means of a sliding average over a specified time frame. The **level of smoothing** can be set in the **Smoothing** function; here you specify the number of measured values to be averaged (possible range 0 to 99). The smoothed measured value then applies for all subsequent evaluation functions. Smoothing can thus also be used in a combination with averaging over individual measured values (see 11.4.3) or for networked measuring (see 11.4.4).

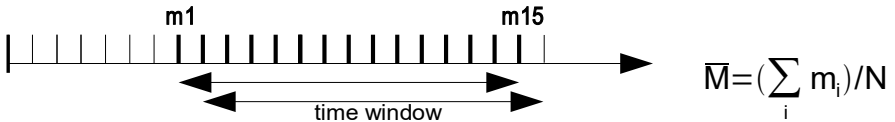

Measured value smoothing over e.g. 15 values : **Smoothing: 15**

When a large number of measuring points is involved, continuous measuring point scanning should be switched off; the measuring rate might otherwise be substantially reduced. **Meas. rate: 10 meas. op. / second Cont: -**



Time constant (s) = **smoothing / measuring rate · (measuring points + 1)**  
is calculated and displayed by the averaging wizard.

### 11.4.2 Averaging mode

For a detailed description of averaging over measuring point scans see the Manual 6.7.4.. The averaging method is defined for each channel in the **Averaging mode** function. Below are the methods available, shown with averaging mode and operation :

Function - No averaging : **Averaging mode: -----**

Averaging over individual measuring operations **MANU** or over all measured values from **START** to **STOP**: **Averaging mode : CONT**

Averaging over all measured values in a cycle: **CYCL**

Lights up so long as averaging is in progress : **M**

**Display** of average value in function **Average value: 12.34 m/s**



For **recording** average values you will need a **function channel** with range  $M(t)$  (see 12.3.9/10) or the corresponding **output function**  $M(t)$  instead of the measured value (see 12.4.5).

### 11.4.3 Averaging over individual manual measuring

To obtain the average of individual measuring operations at particular locations or times individual manual measuring point scans  $E_i$  must be performed. At all measuring points where measured values are to be averaged averaging must be switched on with 'CONT' mode.

## 11. Measuring with the measuring menus



1. If a measuring operation has been started stop it by pressing **<STOP>**
2. Set averaging mode (see 10.5) **Averaging mode CONT**  
 For measured value smoothing, if necessary, select Smoothing **Smoothing 20**  
 If necessary switch continuous measuring off **Meas. rate: 10 meas./s Cont: [ ]**
3. After selection (see 10.4.) to clear average value press **<CLR>**  
 Average value function shows **Average value: ----- m/s**  
 Number function shows : **Number : 00000**
4. Acquire individual measured values Ex manually : **<MANU>**  
 Average value function shows **Average value: 12.34 m/s**  
 Number function shows : **Number : 00001**
5. Repeat step 4 for each measuring point.
6. To output all function values of the menu press **<PRINT>**

### 11.4.4 Networked measuring

Average velocity in a flow channel is calculated as per VDI/VDE 2640, namely by performing measuring operations at particular networked points in a cross-section vertical to the pipe axis (see Manual 3.5.5). To log all the individual values or to be able to repeat incorrect measuring operations a special menu is provided for networked measuring. This special menu can be accessed via the Average value function by pressing **<ARRAY>**. This menu can also be used of course for other point measuring operations.

**Net measurement Points: 5**

01: 11.43 m/s  
 02: 12.51 m/s  
 03: 19.71 m/s  
 04: 12.51 m/s  
 05: --.-- m/s

**Average value : 14.51m/s**

**STOP CLEAR F ESC**

1. The averaging mode is not significant : **Averaging mode : ----**  
 For measured value smoothing, if necessary, select Smoothing **Smoothing 20**
2. Select Average value function **Average value -----**
3. To select the networked measuring menu press **<ARRAY>**
4. For data acquisition press **PROG**
5. Enter number of points **Net. measuring Points [5]**  
 A deleted array appears
6. To select a measuring point press **[ ] 01: --.-- m/s**
7. To start the measuring operation press **<START> 01: 11.22 m/s**
8. To stop the measuring operation press **<STOP> 01: 11.43 m/s**
9. Acquire all points as per steps 6 to 8.
10. To delete the array and new measuring operation press **<CLEAR>**
11. To return to the measuring menu press **<ESC>**

### 11.4.5 Averaging over the measuring time, measuring duration

To determine the average value of all meas. values, that were acquired over the conversion rate, over a defined period, the averaging mode 'CONT' must be set for the required measuring channel. Averaging can be performed either with or without the cycle. A measuring point scan is always performed at start-up and stop in order to record the start value and end value each with the applicable time-of-day. In order to record the average value  $\bar{M}$  function channel  $M(t)$  (see 12.3.9, 12.3.10) is needed.

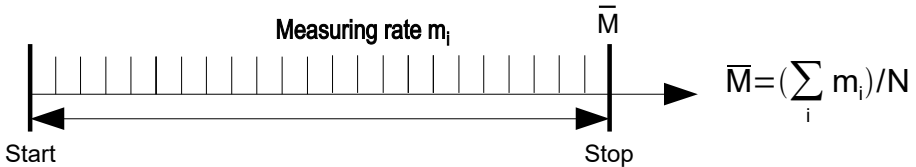

Set averaging mode

Clear average value automatically at start-up (see 12.5.8) or after selecting the averaging value and pressing

To start averaging press

Read out the meas. time (see 11.4.6) in function

To stop averaging press

For a fixed mean time the following function is used

Read out average value in function

To output all function values of the menu press

**Averaging mode CONT**

Verification

**<CLR>**

**<START>** **M**

**Meas.time: 00:01:23.40**

**<STOP>** **||**

**Meas. duration 00:02:00**

**Average value: 3.24kms**

**<PRINT>**

### 11.4.6 Measuring time, measuring duration, timer

For averaging over time (see above) and for many other measuring operations the actual measuring time, from start to stop, is required. For continuously monitoring the measuring time - without clearing the real time - the Measuring time function is provided; this has the format hh:mm:ss.xx with a resolution of 0.10 seconds. If the function 'Clear measured values at start of measuring operation' is activated in the operating parameters (see 12.5.8) the measuring time will also be cleared automatically at each start-up.

Function Measuring time

**Measuring time 00:00:00.00**

To clear the measuring time in Measuring time function press

**<CLEAR>**

#### Measuring duration

If you want to stop a measuring operation or an averaging process (see above) after a certain length of time, you can program the measuring duration in the menu **Times - Cycles** (see 12.1.4) or in a user menu; (this function is displayed in the status bar as **||**).

Measuring duration function

**Measuring duration 00:00:00**



When recording to memory use a programmed measuring duration to ensure that recording does not abort prematurely.

### Timer as function channel

Measuring times can be output and saved via the function channels 'Time' in the format 'sssss' or 'ssss.s' (see 12.3.9). The 2nd timer with 0.1 seconds resolution can be obtained by programming the exponent to -1. At a count of 60,000 the timer is reset and starts again at 0. All the normal start / stop functions can be used; in addition, the start, stop, output, and zero-setting of the 2nd timer can also be triggered by actions in the event of limit values being exceeded; (see 12.4.3).

### 11.4.7 Averaging over the cycle

To acquire average values at cyclic intervals over cyclic periods the averaging mode 'CYCL' must be used. This ensures that the average value, maximum value, and minimum value are cleared after each cycle but continue to appear in the display throughout the following cycle.

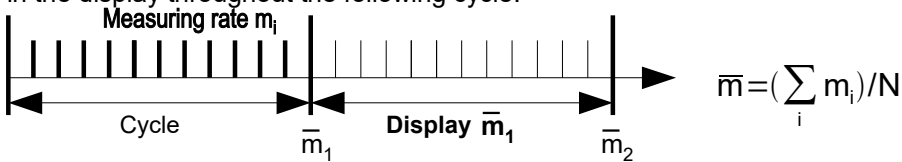

Set averaging over a cycle

To program the cycle (see 12.1.2):

Start measuring operation, averaging runs

Stop measuring operation

Read out average value / cycle in average value function **Aver. val. 13.24 ms**

To output all function values of the menu press

**Average value over manually set periods of time :**

Using the same averaging mode but without the cycle the average value can also be obtained over the period of time from one manual measuring point scan to the next measuring point scan.

Set averaging over a cycle

Select the cycle and clear by pressing

Start measuring operation, averaging runs

Manual measuring point scan

Average value over period from one measuring point scan to the next **Average value 12.34 ms**



For recording average values you will need an additional function channel with range M(t) (see 12.3.9, 12.3.10) or the corresponding output function M(t) instead of the measured value (see 12.4.5, Manual 6.10.4).

```

Averaging mode  CYCL
Cycle           00:15:00
Check
<START>        ▶  $\bar{m}$ 
<STOP>         ||
Aver. val. 13.24 ms
<PRINT>
    
```

```

Averaging mode  CYCL
<CLR>
Cycle timer: 00:00:00
Check
<START>        ▶  $\bar{m}$ 
<MANU>         ▶ ...
    
```

### 11.4.8 Averaging over measuring points

In all measuring point scans the average value can also be determined over a number of associated measuring points. However, for this average value a function channel with the measuring range M(n) must be available (see 12.3.9). If you do not wish to program reference channels and the measuring points to be averaged begin with M0, you need simply to program the function channel M(n) to the 2nd channel of the last connector (e.g. M13) (see 12.3.10). This will then refer automatically to the series from reference channel 2 (M0) through to reference channel 1 (M3 = 1st channel). Other ranges of measuring points can be activated by programming the reference channels accordingly (see 12.4.6). The function channel can be configured quickly and easily by means of the wizard menu **Averaging**.

```

AVERAGING
over range of meas. Points:
From meas. channel :
00: 234.5 °C NiCr
to meas. channel :
03: 189.7 °C NiCr

Program function channel
to channel:
13: 213.7 °C M(n)
Range: M(n)

START MANU M ESC
    
```

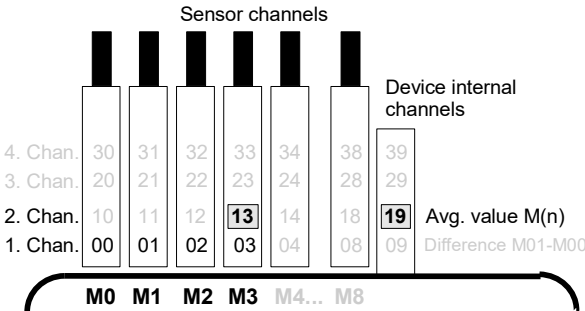

$$\bar{M} = \left( \sum_{i=Bk2}^{n=Bk1} M_i \right) / N$$

Example:

$$M13 = \left( \sum_{i=M0}^{n=M3} M_i \right) / N$$

$$M13 = \bar{M} \text{ from } M0 \text{ to } M3$$

If the sensors are to remain unaffected, the function channel can be programmed to the device-internal channels (e.g. M19) (see 12.3.10). The default reference channels are M0 to M1.

### 11.4.9 Volume flow measurement

The **volume flow** in flow channels can be calculated by multiplying the average flow velocity and the cross-section surface.  $\bar{v}$  The functions needed for this purpose can be accessed via the user menu U3 **Volume flow** (see right); these are a flow channel with averaging, the functions “diameter” and “cross-section”, and a function channel for volume flow (see 12.3.10). If the volume flow channel has not yet been programmed or if other functions are needed, e.g. profile factor or length and width for rectangular cross-sections, you can use the wizard menu **Volume flow**.

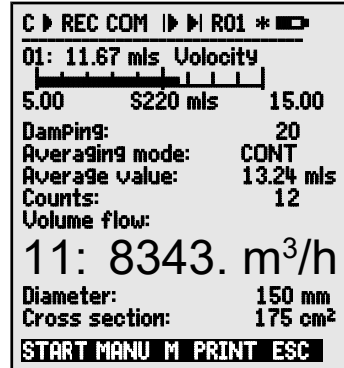

**Volume flow**  $VF = \text{average flow velocity } \bar{v} \cdot \text{Cross-section surface } CS$

$$VF = \bar{v} \cdot CS \cdot 0.36 \quad VF = \text{m}^3/\text{h}, \bar{v} = \text{m/s}, CS = \text{cm}^2$$

**The average flow velocity**  $\bar{v}$  For rough air volume measurements at air vents and gratings the average flow velocity can be determined by means of **time-based averaging** (see 11.4.5 and Manual 3.5.5). You apply the rotating vane at one end, start averaging, and proceed uniformly over the whole cross-section; when you reach the other end of the cross-section stop averaging.

Or alternatively the average flow velocity can also be determined by means of **single array measuring operations** as per VDI/VDE 2640 (see 11.4.4 and Manual 3.5.5) (e.g. 13.24 m/s).



To display, output and save the number of measuring operations the function channel 'n(t)' is also provided (see 12.3.9, 12.3.10).

With Pitot tubes, in order to calculate actual velocity, temperature compensation and atmospheric pressure compensation must be provided.

The average velocity is shown by the function  $\bar{v}$

Enter the diameter in mm (maximum 2000):

Enter the cross-section surface CS directly in  $\text{cm}^2$ :

Display the volume flow VF in a

function channel in  $\text{m}^3/\text{h}$ :

To output all function values of the menu press

**Converting to standard conditions**

With all flow sensors it is possible to convert the actual measured values to standard conditions, i.e. temperature = 20°C and atmospheric pressure = 1013 mbar. To do this '#N' must be programmed in the designation either in the speed channel or in the volume flow channel only; this then automatically produces the standard volume flow.

Averagevalue: 3.24m/s

Diameter: 0150 mm

Cross-section: 175cm²

volume flow

11: 834.m³/h

<PRINT>

## 11.5 Display of several measuring points

The measuring menus described so far are used for selecting and displaying one meas. point only. In this Chapter we explain how several measuring points can be displayed at the same time combined with the functions of your choice.

### 11.5.1 Menu Multi-channel display and bar charts

The menu Multi-channel display initially shows the measured values of the first three active channels in medium size. However, these can be programmed in numerous ways.

In the menu **Bar charts** the first four active channels are displayed with measured value and bar chart.

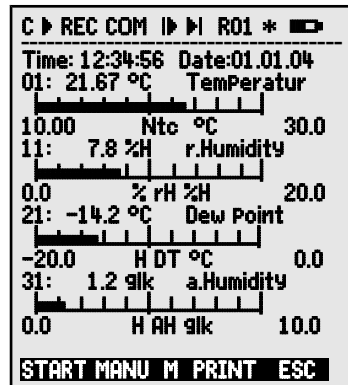
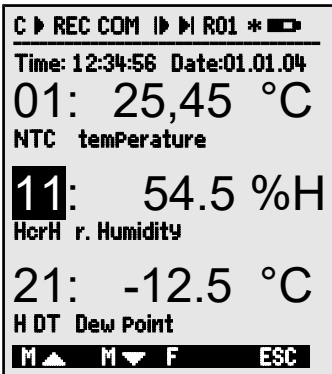

#### Measuring point selection

The 1st measuring channel is always the selected measuring point.

This can be selected directly by means of

To change the other channels, the measuring point must be selected as function by pressing

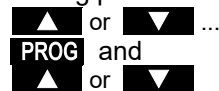

The selected measuring point can now be changed by means of



To terminate the process of measuring point selection press



To **set the display range** for the bar chart the functions "analog start" and "analog end" in the **special functions menu** should be used (see 12.4.4). Having selected these functions they can be entered by pressing **PROG** and or directly on the appropriate axis; (see 10.5).

### 11.5.2 Differential measurement

If there are two sensors with the same units and same decimal point position connected at measuring points M0 and M1, the difference M1 - M0 appears automatically below device-internal measuring point M9 (see 8.2). If the differential channel is not required, it must be deleted(see 12.3.9). If further differential channels are needed, these can also be created using the appropriate reference channels (see 12.4.6).

### 11.5.3 Menu Measuring points list

The best overview of the measuring system with all measured values, date, time-of-day, and cycle can be obtained via the **Measuring Points list** menu. From the measuring points you can also reach **Sensor Programming** for the measuring points.

This menu cannot be configured by the user; it can only be combined with certain selected functions.

Initially the list appears with maximum 20 measured values.

To select further measuring points press  
The measured value can be linked to a series of functions by pressing  
This reduces the maximum number of channels to 10.

To advance to the next function press  
Measured value with **Comment**

Measured value with **Maximum value**

Measured value with **Minimum value**

Measured value with **Average value**

Measured value with **Limit value, maximum**

Measured value with **Limit value, minimum**

**Measuring range** only (also maximum 20 channels)

Functions can be selected for programming:

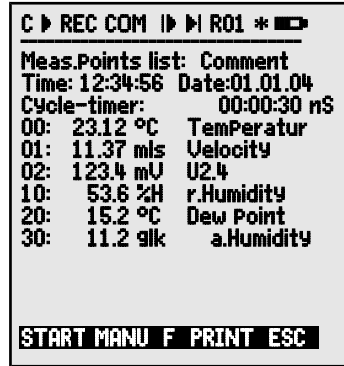

**Measuring Points list : 20 measured values**

00: 23.12°C ...  
PROG , M▲ ... / M▼ ...

▲ or ▼ ...



**Measuring Points list Comment**

00: 23.12°C temperature  
**Measuring Points list Maximum value**

00: 23.12 °C 32.67 °C

**Measuring Points list Minimum value**

00: 23.12 °C 19.34 °C

**Measuring Points list: Average value**

00: 23.12 °C 25.45 °C

**Measuring Points list Limit value, maximum**

00: 23.12 °C 32.67 °C

**Measuring Points list Limit value, minimum**

00: 23.12 °C 19.34 °C

**Measuring Points list Range**

00: NTC °C

PROG , ▲ / ▼ ...



## 11.6 Wizard menus for special measuring operations

Special measuring operations, i.e. thermal coefficient or wet bulb globe temperature, require a series of sensors in a particular arrangement and function channels programmed for calculating the required variables. To ensure that these two special measuring operations can be performed quickly and easily there is a special wizard menu for each.

### 11.6.1 Thermal coefficient

To determine the thermal coefficient the two temperature sensors are connected as required (see Manual 3.2) to channels M0 and M1 and the heat flow plate to M2.  $\bar{q}/(T_1 - T_0)$   
The temperature difference  $T(M1) - T(M0)$  is obtained automatically on channel M9.

For this measuring operation the following programming steps are needed :

Averaging mode of M9      **CONT** or **CYCL**

Averaging mode of M2      **CONT** or **CYCL**

Range of M12                **q/dt**

Enter cycle by means of    **Cycle timer**

To start meas. operation press    **<START>**

To stop meas. operation press    **<STOP>**

Wizard menu for thermal coefficient

```

Inner temp. T0:      Channel: 00
00: 21.67°C NiCr
Outer temp. T1 :    Channel: 01
01: 11.42°C NiCr
Difference dt:      Channel: 05
05: 10.25°C Diff
Averaging mode:    CONT
Heat flow q         Channel: 02
02: 103.6 W/m²
Averaging mode:    CONT
- Thermal coeff. Channel 12
12: 193. W/mK
1 Range            q/dt
Cycle timer:       00:30:00 Sm
START MANU      ESC

```

### 11.6.2 Wet bulb globe temperature

The stress caused in heat-exposed workplaces can be evaluated in terms of their wet bulb globe temperature calculated according to the following formula :

$WBGT = 0.1 DT + 0.7 HT + 0.2 GT$  (see Manual 3.1.4)

To measure the dry temperature (DT) and the natural humid temperature (HT) a psychrometer (FN A848-WB) with turn-off motor is connected to socket M0. A PT100 globe thermometer is connected to socket M1. Channel 11 is programmed for WBGT; (for this device the factor 0.2 must not be programmed).

Wizard menu for wet bulb globe temperature

```

WET BULB GLOBE TEMP.
-----
ry temperature: Channel: 00
00: 21.67°C Ntc
Humid temp:      Channel: 10
10: 11.42°C HT
Globe temp:      Channel: 01
01: 19.42°C P204
-----
Wetbulb9lobe temp. Channel 11
11: 17.43 °C
1 Range          WBGT
START MANU      ESC

```

## 11.7 User menus

Looking at the standard measuring menus you might conclude that the display of measured values and the combination of functions are not always ideally suited to the requirements of your particular applications. You are provided therefore not only with the standard measuring menus but also with three user menus **U1** to **U3** which you can freely configure using the AMR-Control software. You can choose the functions you require from the following list and arrange these on the display exactly as you wish; the only restriction is the available space, namely 13 rows. You can use not only the various measuring functions already described but also various timers for sequence control (see 12.1) and most of the sensor programming functions (see 12.3).

### 11.7.1 Functions

Functions	Display	Keys		Com- mand
Measured value - small	00: 234.5 °C temperature	ZERO	ADJ	o 15
Measured value - medium 3 rows	00: 1234.5 °C	ZERO	ADJ	o 16
Measured value - large 7 rows	00: Temperature °C 1234.5	ZERO	ADJ	o 17
Measured value, bar chart 2 rows	 5.0      5.220 m/s      15.00			o 34
Limit value - maximum (s. 12.3.5)	Limit max 1234.5 °C	OFF	ON	o 00
Limit value - minimum	Limit min -0123.4 °C	OFF	ON	o 01
Base value (see 12.3.6)	Base value -----°C	OFF	ON	o 02
Factor	Factor 1.12345	OFF	ON	o 03
Exponent	Exponent 0	OFF	ON	o 48
Zero-point corr.(see 12.3.7)	Zero-Point -----°C	OFF	ON	o 04
Gain corr.	Gain -----	OFF	ON	o 05
Analog start (see 12.4.4)	Analog start 0.0 °C	OFF	ON	o 06
Analog end	Analog end 100.0 °C	OFF	ON	o 07
Range (see 12.3.9)	Range NiCr	CLR		o 08
Maximum value (see 11.1.2)	Maximum 1122.3 °C	CLR	CLRA	o 09
Minimum value	Minimum 19.3 °C	CLR	CLRA	o 10
Average value (see 11.4.5)	Average -----	CLR	CLRA	o 11
Cycle (see 12.1.2)	Cycle 00:00:00 Un	CLR	FORM	o 12
Time, date (see 12.1.1)	Time:12:34:56 Date:01.02.00	CLR		o 14
Averaging mode (see 11.4.2)	Averaging mode CONT	CLR		o 18
Measuring rate (see 12.1.3)	Meas. rate 10 M/s Cont: -	OFF	ON	o 19
Cycle timer (see 11.3.2)	Cycle timer: 00:00:00 Un	CLR	FORM	o 20
Mean number (see 11.4.3)	Number 00000			o 22

Number (see 12.2.3)	Number	123-56	OFF	ON	o 23
Range, designation	NiCr Temperature	M H ↗			o 24
Diameter mm (see 11.4.9)	Diameter	0000 mm	CLR		o 25
Cross-section cm <sup>2</sup> (see 11.4.9)	Diameter	0000 cm <sup>2</sup>	CLR		o 26
Max-time-date (see 11.1.2)	Max time	12:34 01.02.			o 28
Min-time-date	Min time	13:45 01.02.			o 29
Empty line					o 30
Line					o 31
Smoothing (see 11.4.1)	Smoothing	10	CLR		o 32
Memory free (see 11.3.3)	Memory free	502.1 KB	CMEM	PRINT	o 33
Device designation (see.12.5.1)	Company name - A	Specimen	CLR		o 36
Text1:	1: Designation line		CLR		o 37
Text2	2: Designation line		CLR		o 38
Text3: (see 11.7.)	Menu title U1		CLR		o 39
Text4:	Menu title U2		CLR		o 40
Text5:	Menu title U3		CLR		o 41
Locking (see 12.3.4)	Locking level	5	CLR		o 42
Atmospheric pressure (s. 12.5.6)	Atm. Pressure	1013 mbar	CLR		o 43
Temp. comp. (see 11.2.5)	Temp.Comp	CT 25.0 °C	CLR		o 44
Setpoint (see 11.2.4)	SetPoint	1100.0 °C	OFF	ADJ	o 45
Measuring time (see 11.4.6)	Meas. time	00:00:000.00	CLR		o 46
Measuring duration (see 12.1.4)	Meas.duration	00:00:00	CLR		o 47
Menu end					o 99

## 11.7.2 Menu configuration

From the measuring menu choose a user menu

**U1**, **U2** or **U3**, that you do not need at the moment:

**MEASURING menu:**



To configure this please connect the device via a data cable to your PC and start the AMR-Control software.

Click once with the mouse on

You then reach

Select the device and press

Search the network

Device list

Program user menus

Choose the desired functions on the left side and drag-and-drop into the menu window on the right.



For all functions concerning measured values (e.g. maximum, average value, bar chart) you must in each case enter the measured value of the measuring point first and then the associated functions.

You are advised to use a meaningful menu title : User menu title

Once completed save the menu in the device as Ux : Save menu, Ux, OK

You can also save all your menus on the PC and reload these as and when required.

### 11.7.3 Function printouts

You can print out the functions of all measuring menus in the order displayed by pressing **<PRINT>** (see 11.3.4).

The print layouts for these functions are listed in the following table :

Function	Printout	Command
Meas. value, all formats	01: +0023.5 °C temperature	P35
Maximum value	MAX VALUE : 01: +0020.0 °C	P02
Maximum time	MAX TIME 01: 12:32 01.02	P28
Minimum value	MIN VALUE : 01:-0010.0 °C	P03
Minimum time	MIN TIME 01: 12:32 01.02	P29
Average value	AVERAGE 01: +0017.8 °C	P14
Averaging mode	AVERAGING MODE 01: CONT	P21
Number of averaged val.	NUMBER OF AVERAGED VALUES 01:	P22
Memory capacity free	MEMORY S0512.1 F0324.4 A	P33
Number	NUMBER 01-012	P23
Range (designation)	RANGE 01: NiCr	P24
Limit value, maximum	LIMIT, MAX 01: -0100.0 °C	P08
Limit value, minimum	LIMIT, MIN 01: +0020.0 °C	P09
Base value	BASE VALUE 01: -0273.0 °C	P06
Factor	FACTOR 01: +1.0350E-1	P07
Zero-point correction	ZERO-POINT 01: -0000.7 °C	f1 P06
Gain correction	GAIN 01: +1.0013	f1 P07
Analog start	ANALOG START 01: +0000.0 °C	P16
Analog end	ANALOG END 01: +0100.0 °C	P17
Cycle	PRINT CYCLE 00:06:00	P11
Cycle timer	PRINT TIMER 00:06:00	f1 P11
Date, time-of-day	TIME-OF-DAY 12:34:00	P10, P13
Start time	START TIME 07:00:00	f1 P10
End time	END TIME 17:00:00	f2 P10
Start date	START DATE 01.02.04	f1 P13
End date	END DATE 02.02.04	f2 P13
Measuring time	MEASURING TIME 00:00:00.00	P46
Measuring duration	MEASURING DURATION 00:00:00	P47
Smoothing	SMOOTHING 01: 10	P32
Diameter	DIAMETER 01: 00100 mm	P25
Cross-section	CROSS-SECTION 01: 00078 cm2	P26
Atmospheric pressure	ATMOSPHERIC PRESSURE +01013	P43
Temp. compensation	COMPENSATION 01: 25.0 °C	P44
Setpoint	SETPOINT 01: 1100.0 °C	P45
Device designation	Ahlborn, Holzkirchen	P36
Line	-----	P31
Empty line		P30
Text1	Comments text 1	P37
Text2	Comments text 2	P38
Text3	Menu title U1	P39
Text4	Menu title U2	P40
Text5	Menu title U3	P41
Locking mode	Locking level 5	P42

## 12. PROGRAMMING USING THE PROGRAMMING MENUS

So far in looking at the measuring menus you have got to know not only the various measuring functions but also a series of functions for process control and sensor programming.

A comprehensive and systematic list of all programming functions is provided here in our description of the **PROGRAMMING menus**.

You can access the selection menu from the measuring menu selection by pressing **◀MENU1**.

For certain programming functions there are also **WIZARD menus** available.



### 12.1 Times and cycles

All time functions used for measuring, process control, and logging purposes can be collated and programmed in the programming menu **Times - cycles**.

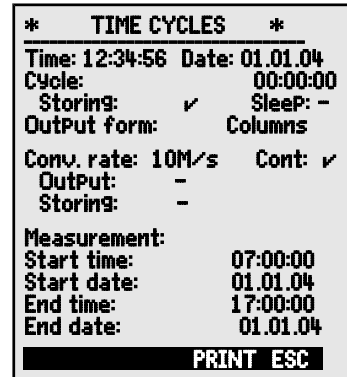

#### 12.1.1 Date and time-of-day

The ALMEMO 5690-2M incorporates an integrated real-time clock with date and time-of-day for logging measuring times.

It has a lithium battery so the time and date are also maintained after battery change. The first line contains the time-of-day on the left and the date on the right; by selecting this function (see 10.4) these can be programmed in the format indicated (see 10.5).

**Function Date and time-of-day**

Format of time-of-day and date:

**Time:12:34:56 Date :01.05.00**

hh:mm:ss

dd.mm.yy

#### 12.1.2 Cycle with memory activation and output format

For cyclic saving of and output via the interface of measured values use the **Cycle :** (this corresponds to the print cycle with other ALMEMO® devices; the measuring cycle is no longer implemented). Saving in the cycle, i.e. cyclic recording of data to the memory, is automatically activated after each reinitialization but can be deactivated as and when required.

The **output format** (see Manual 6.6.1) defines the print layout for measuring

point scans and for output of the memory. This output format can be programmed in the function **Output form**. There is the default format 'List' in which all measured values are listed one below the other; there is also the 'Columns' format listing them next to one another; this provides a clear, easy-to-understand, and space-saving printout. For this latter format the printer is switched over automatically to compressed character mode. There is also the 'Table' **format** which is suitable for further processing using a spreadsheet program; (see print layouts, Manual 6.1).

**Cycle function** (format hh:mm:ss):

Cycle : 00:15:00

Clear cycle, end current scan:

<CLR>

**Memory activation function in the cycle**

Saving:  Standard: -

Saving to memory activated (default setting):

<ON> ✓

Saving to memory deactivated

<OFF> -

**Activate the sleep mode function** (see 12.2.5):

<ON> Sleep: ✓

**Output format** 'l' List meas. val. one below the other : **Output form : List**

Output format 'n' Columns next to one another : **Output form: Columns**

Output format 't' Table, semi-colon separated : **Output form: Table**

In the measuring menus after the Cycle memory activation ON is indicated by 'S' and OFF by 'U'.

Special format is indicated by an abbreviation 'n' or 't': **Cycle: 00:15:00 \$n**

### 12.1.3 Measuring rate, continuous measuring point scan

As and when necessary the measuring rate (conversion rate) for measuring point scans can be changed, via the **Measuring rate** function, from its standard setting of 10 mops to 2.5 / 50 / 100 mops (see Manual 6.5). There is also an option (SA0000-Q4) for setting the measuring rate to 400 mops but this is only possible for passive selector switch boards and only for 1 measuring point at a time.

#### Semi-continuous measuring point scan

The option of scanning only the selected measuring point (non-continuous) is no longer provided because ignoring all the other sensors may easily lead to errors. However, it may be useful, especially when numerous sensors are being used, to assign preferred priority to the selected measuring point and update its measured value more frequently, e.g. for the purposes of analog output or measured value smoothing. The default setting is therefore now no longer the "non-continuous" but the "semi-continuous" **measuring point scan**, i.e. all measuring points are continuously scanned but the selected measuring point is scanned in each 2nd measuring operation. This reduces by half the total sampling rate required with continuous measuring point scanning.

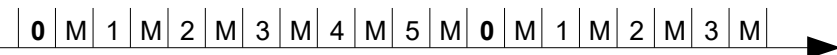

### Continuous measuring point scan

In the setting **continuous measuring point scanning**, all active measuring channels are scanned equally often at the chosen measuring rate and uninterruptedly one after the other and at the end a special measuring operation is inserted; (see Manual 6.5.1.3).

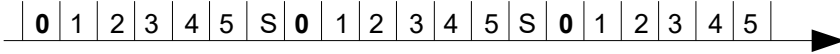

In both modes all measured values can be saved and output at any time. With both the following functions **continuous saving to memory** and **continuous output** of measured values can be activated at the measuring rate.

#### Measuring rate function (see 10.5) Measuring rate: 10 M/s

Semi-continuous measuring point scan	<OFF>	Cont: -
Continuous measuring point scan (standard)	<ON>	Cont: <input checked="" type="checkbox"/>
Continuous saving to memory OFF	Saving:	-
Continuous saving to memory, activate	<ON>	<input checked="" type="checkbox"/>
Continuous output OFF	Output: -	
Continuous output, activate	<ON>	<input checked="" type="checkbox"/>



It should be noted, however, when selecting the measuring rate, that the higher the measuring rate so the lower the measuring quality and, conversely, the lower the rate, the higher the quality.

At measuring rates above 10 measuring operations per second mains hum suppression is not provided; as a result accuracy may be adversely affected by interference over the connection lines; (wherever possible use twisted wires).

Saving to memory at 100 / 400 measuring operations per second is only possible with the SD card but not with the internal EEPROM.

### 12.1.4 Start time Start date End time End date Measuring duration

A measuring series can be started and stopped automatically at specified times. The start date and time-of-day and end date and time-of-day can be freely programmed for this purpose. If no particular date has been programmed, the measuring operation will be performed every day within the set period. This is assuming of course the current time-of-day has been programmed. Or, alternatively, instead of specifying the end time-of-day the measuring duration itself can be programmed; (see 11.4.6, 12.2.2).

<b>Measuring duration function</b> (format hh:mm:ss):	<b>Measuring duration:</b>
00:00:00	
<b>Start time function</b> (format hh:mm:ss):	<b>Start time :</b> 07:00:00
<b>End time function</b> (format hh:mm:ss):	<b>End time :</b> --:--:--
<b>Start date function</b> (format dd:mm:yy):	<b>Start date :</b> 01.05.00
<b>End date function</b> (format dd:mm:yy):	<b>End date :</b> --:--:--

These values can be cleared after selecting the function by pressing **<OFF>**  
 If the start time for a measuring operation has been programmed, the following symbol appears in the status bar :



If the end time or the measuring duration for a measuring operation has been programmed, the following symbol appears in the status bar :



## 12.2 Measured value memory

The basic information on saving data in ALMEMO® devices is provided in the Manual, Section 6.9. The ALMEMO 5690-2M system (option S only) incorporates an internal 512-KB EEPROM with sufficient capacity for 64000 to 100000 measured values (depending on the number of channels). In the event of a failure in the supply voltage the measured data is retained intact. The EEPROM can be configured either as linear memory or ring memory; (see Manual 6.10.13.2). Or, alternatively, a SD card can be used in the default slot for this purpose (4).

### 12.2.1 Memory with memory card

Any conventional SD memory card (or micro SD with adapter or a multimedia card) can normally be used for external memory. This offers virtually limitless memory capacity; data can thus be evaluated elsewhere as and when required. The memory card can be formatted and its contents can be read and deleted via any normal PC using any card reader. Measured data can be imported into MS-Excel or into Win-Control (the accompanying measured value software). The memory card is inserted in slot (4) on the front panel; it is recognized automatically. You can verify this in the menu **Recording to memory** (see 12.2.2) and the function **External memory** by the increased memory capacity and the file name in the function **File name**. If the external memory is connected at the start of any measuring operation, it will be used. However, in the course of the measuring operation it must not be unplugged; this would cause temporarily buffered measured values to be lost.

Memory capacity available, external

**External memory: 64.00 MB**

Memory capacity free

**Memory caPacity free : 21.75 MB**

File name (maximum 8 characters)

**File name: ALMEMO.001**

Before starting any measuring operation you can, in the function **File name**, enter an 8-character file name. In the absence of a user-assigned file name, the default name 'ALMEMO.001' or the name most recently used will be suggested automatically. So long as the connector configuration is not altered, you can save several measuring operations, either manually or cyclically, also with numerical assignment, all in the same file (see 12.2.3).

If, however, the **connector configuration** has been changed since the last measuring operation and if no new file name has been programmed, then a new file is always created and in so doing the index in the file name extension is automatically incremented by 1, e.g. 'ALMEMO.002'. Similarly, if the file name



entered already exists, then a new file will be created with the same file name prefix but with a new index.

The memory card is monitored to ensure correct functioning; an LED indicates the following activities and states :

Data is being recorded. LED flashes in the same rhythm as the cycle.

Data is being read out. LED lights up continuously for the duration of data output.



The ring memory function is not supported with external storage media.



When using a memory card for storing measurements at a conversion rate of 100 mops, measuring faults can occur when the device is mains-supplied but the housing not connected to protective ground. In such cases it is recommended to establish connection between ground socket of the ALMEMO® instrument and protective ground.

### 12.2.2 Measured data, recording

Most of the parameters needed for the **recording** of meas. values have already been examined in our description of the menu **Times - cycles** (s. 12.1).

1. Date and time-of-day
2. Cycle, memory activation, sleep mode
3. Measuring rate with memory activation
4. Start time and end time for a measuring operation

The preparations for recording to memory can be made most easily using the menu **Recording to memory**.

There are numerous methods available for starting and stopping a measuring operation, some also with their own wizard menus (see 12.2.4).

* RECORDING TO MEMORY *	
Memory internal:	512.0 kB
Memory free:	125.8 kB
Ring memory:	✓
Meas.channels: 24	active: 05
Cycle:	00:01:00.00
Storing:	✓ Sleep: -
Storing time:	24d 13h
Meas. duration:	00:01:00
Number:	01-001 A
<b>CLR</b>	<b>MIN F ESC</b>

**PLEASE NOTE !** The first time the device is started only one sensor configuration is saved to the internal memory; however, with effect from the next start this can be supplemented by additional sensors. However, if other sensors are connected the memory must be read out and then cleared before the next recording session.

Menu **Recording to memory** :

Memory capacity available, internal

Memory capacity free

Memory capacity available, external

**Linear memory** without overwriting

**Ring memory** with overwriting

internal memory : 512.0 KB

Memory free : 217.5 KB

External memory: 64.01 MB

Ring memory -

<ON> ✓

## 12. Programming using the programming menus

**Active channels** for min. cycle and available memory time

**Enter cycle** (see 10.5, format hh:mm:ss.cc):

**Minimal cycle** with 50M/s corresp. to active channels:

Cycle without saving and without sleep mode

To select and activate **saving to memory** press

To activate **sleep mode** (see 12.2.5) press

**Available memory time** from cycle and channel number

**Measuring duration**, after start; automatic stop after :

**File name** with memory connector (maximum 8 characters)

**Number** e.g. room 12, measuring point 1 (see 12.2.3)

Meas. chan.: 24 active : 05

Cycle: 00:01:00.00

<MIN> 00:00:00.12

Saving: - Standard: -

<ON>  Standard: -

<ON> Standard:

Memory time: 24d 13h

Meas. duration : 00:15:00

File name : ALMEMO.001

Number : 12-001 A

### 12.2.3 Numbering of measuring operations

To identify measurements or series of measurements these can be individually numbered before starting. This number is output or saved when the next measuring point scan starts. In this way individual measuring operations can be assigned to certain types of measurement or certain measuring points (see Manual 6.7).

After selecting the function **Number** the 6-character number is entered as normal (see 10.5). You can use digits 0 to 9 and also the characters A, F, N, P, and - or \_ (space). The number is activated as soon as it has been entered; it will then be followed by the letter 'A' until the next cyclic or manual measuring operation is saved.

**Number function** (e.g. room 12, measuring point 1)

To **zero-set** and deactivate the number press

To **activate** and **deactivate** the number press

To **increment** and **activate** the number press

NUMBER: 12-001 A

<CLR>

<ON>, <OFF>

<+1>

### 12.2.4 Starting and stopping measuring operations

A measuring operation can be started and stopped not only by pressing the appropriate keys but also using numerous other methods provided in the START - STOP wizard menu. Operation via the interface is described in the Manual, Section 6.6. The function using a start time and end time or measuring duration is described in Section 12.1.4, limit value actions in Section 12.4.3, and the relay and trigger variants in Section 12.6.2.



### 12.2.5 Scanning mode

For autonomous operation and / or for scanning by computer there are 4 scan-

ning modes available :

- Normal** Internal cycle or cyclic scanning by the computer
- Sleep** Internal cycle only, automatically switching off for long-term monitoring
- Monitor** Internal cycle, not disturbed by computer scanning
- Fail-safe** Cyclic scanning by the PC, after any failure affecting the internal cycle

**Sleep mode**

For long-term monitoring involving large measuring cycles the system can also be operated in sleep mode. In energy-saving sleep mode the measuring instrument is completely switched off after each measuring point scan please note when using sensors with power supply) and switched on again automatically after the cycle expires ready for the next measuring point scan. In this way with just one set of batteries or one battery recharge up to 15000 measuring point scans can be performed; for a cycle lasting 10 minutes this represents a measuring capability of over 100 days.

For **data recording in sleep mode** go to the menu **Recording to memory** and take the following steps :

- |  |   |
|--|---|
| 1. Enter a cycle lasting at least 2 minutes        | <b>Cycle :</b> 00:05:00 \$  |
| 2. Activate saving in this cycle                   | <b>Saving:</b> <input checked="" type="checkbox"/> <b>Normal:</b> -                       |
| 3. Select sleep mode                               | <b>Saving:</b> <input checked="" type="checkbox"/> <b>Sleep:</b> <input type="checkbox"/> |
| 4. To switch sleep mode on press                   | <b>&lt;ON&gt;</b> <b>Sleep:</b> <input checked="" type="checkbox"/>                       |
| 5. In a measuring menu start a measuring operation |   |
|  | by pressing <b>&lt;START&gt;</b>  |

The device should then display

**Sleep On.**  
LED 'SLEEP' (2) flashes

The display then switches off; the LED 'SLEEP' (2) flashes rhythmically on and off as verification.

- |   |                     |
|---|---------------------|
| 6. In the specified cycle the instrument switches on automatically, performs one measuring point scan, and then switches off again. |                     |
| 7. To terminate sleep mode press  | <b>&lt;ON&gt;</b>   |
| 8. To terminate the measuring operation press   | <b>&lt;STOP&gt;</b> |



The start or stop through start and end time or through limit values is, on principle, not possible in sleep mode and, therefore, must be switched off!

**Monitor mode**

This new "monitor mode" should be used when a data logger, being operated on a cyclic basis, is to be monitored occasionally by computer. Internal cyclic scanning is not influenced in any way by software scanning; (in Win-Control "safe initialization" must be switched off).

The internal cycle is started as and when the software starts; it may also have been started previously. When scanning with the internal cycle no data is output to the interface. In order to record data the memory must have been acti-

vated. In the **Mode** function program the variant **Monitor** :

**Mode : Monitor**

**Fail-safe mode**

The "fail-safe mode" is suitable when scanning is purely software-based; it merely ensures, in the event of computer failure, that scanning will continue on an internal cyclic basis. In this mode the cycle programmed in the device must be longer than that needed for software scanning. Software scanning keeps resetting the internal cycle with the effect that this cycle is only actually used as and when software scanning fails; (in Win-Control "safe initialization" must be switched off).

The internal cycle is started as and when the Win-Control software starts; it may also have been started previously. When scanning with the internal cycle no data is output to the interface. In order to record data the memory must have been activated.

In the **Mode** function program the variant **Fail-safe** : **Mode : Fail-safe**

**12.2.6 Memory output**

The contents of the internal measured value memory can be output completely or in excerpts via the serial interface. With each output any one of the three known output formats may be used "list", "columns", or "table".

The option to specify partial ranges is available as it is possible to set the start and end time of measurements and also possible to select the number of corresponding identified measurements.



With **external memory cards** (see 12.2.1) there is only one option available, namely output in table mode of

all the measured data contained in the file most recently used. For this purpose use only the **PRINT** key in the **Memory capacity free** function in the **Memory output** menu or in certain measuring menus.

The most sensible approach is to remove the memory card and copy the files via a USB card reader directly onto the PC. These can then be imported either into MS-Excel or into Win-Control (as of V.4.9).

* OUTPUT FROM MEMORY *	
Memory Internal:	512.0 kB
Memory free:	125.8 kB
Residual output:	12.5 kB
Output form:	Columns
Number:	01-001 A
Time: 12:34:56	Date: 01.01.04
Time interval:	
Start time:	07:00:00
Start date:	01.01.04
End time:	17:00:00
End date:	01.01.04
<b>ALL NR F TIME ESC</b>	

Menu **Memory output** :

Set the **output format** (see 12.1.2):

**Output format : List**

To **select a numbered measuring operation**:

**Number: 12-001**

In the **Number** function select the number by pressing

**<FIRST>, <NEXT> ..., <LAST>**

To **select a time frame**:

Enter the start time in format 'hh:mm:ss' :

**Start time : 07:00:00**

Enter the end time in format 'hh:mm:ss':	<b>End time :</b>	<b>17:00:00</b>
Enter the start date in format 'dd:mm:yy':	<b>Start date:</b>	<b>01.05.00</b>
Enter the end date in format 'dd:mm:yy':	<b>End date:</b>	<b>01.05.00</b>

Output the measured value memory in full

**<ALL>**

Output measuring operation with its number

**<NR>**

Output the time frame from start to end

**<TIME>**

To stop memory output press

**<STOP>**

The content of the internal memory is output with the same print layout as when printing; this also applies to multiple outputs in various formats; (this does not apply for the memory card) (see Manual 6.6.1).

During memory output, in the **Remaining output** function, the amount still to be output is continuously updated and displayed in KB. The current values for time-of-day, date, and number are also shown.

Remaining amount of memory to be output	<b>Remaining output: 12.5 KB</b>
Current number of memory output	<b>Number: 01-001</b>
Current date and time-of-day of memory output	<b>Time:12:34:56 Date:01.01.04</b>

### Clearing the memory

Select the **Memory capacity free** function (see 10.4): **Memory free: 330.5KB**

To clear the memory press

**<CMEM>**

- If a memory card is being used, the card will be reformatted and all files will be deleted.

The full capacity will be shown as available memory. **Memory free: 512.0 KB**

To cancel press

**<ESC>**

## 12.3 Sensor programming

Since on ALMEMO® devices all sensor programming is stored in the ALMEMO® connector itself, the user will not normally need to reprogram each time. Programming will only be necessary e.g. if sensor errors are corrected, if your own sensors are scaled, or if certain limit values are stipulated; in these circumstances there are comprehensive programming functions available.

In the menu **SENSOR PROGRAMMING** all parameters for a channel can be entered, viewed, checked, and modified via the keypad providing the sensor connector is plugged in. Please note that series sensors featuring the locking mode can be protected against unintended alteration and that if modification is required this locking mode must first be lowered to an appropriate level (see 12.3.4). Functions can only be selected if the locking mode allows; all other functions remain grayed out.

To output sensor programming of all active measuring points (command P15, see Manual 6.2.3) press

```

* SENSOR PROGRAMMING *
_Connector: 0      Channel: 00
Comment:          TemPeratur
Averaging mode:   CONT
Locking mode:     5
7 Limit max:      35.0 °C
7 Limit min:      -----
5 Base:           -----
5 Factor:         -----
5 Exponent:       0
4 Zero correct:   -----
4 SloPe correct:  -----
2 Dimension:     °C
1 Range:         NiCr
MALL      M PRINT ESC
<PRINT>
    
```

### 12.3.1 Selecting the input channel

To view or edit a sensor's parameters you must first of all select the menu **SENSOR PROGRAMMING** and then set the required input channel by pressing **▲** or **▼**. Only sensors actually connected and channels actually activated can be processed. To activate new channels first press **<MALL>** to select all channels. Then press **<MACT>** to reduce this selection again to only those that are **active**. For each input channel the associated connector number is displayed.

Menu **SENSOR PROGRAMMING** :

Display of connector number and channel

Connector: 0 Channel : 00

To select next input channel press



To select previous input channel press



To accept the selection of all possible channels press



To reduce selection to all active channels press



### 12.3.2 Measuring point designation

Each measuring point can be assigned a 10-character alphanumeric designation (all ASCII characters) to denote as clearly as possible the type of sensor, measuring location, and / or purpose. This designation is included in all standard measured value displays. In an output via the interface the measuring point designation appears in the program header as 'DESIGNATION' and also in the measured value list (see Manual 6.6.1).

Input in the 'Designation' function (see 10.5) **Designation : Temperature**

Certain control characters at the beginning of the designation have special functions :

'\*J' This defines a temperature sensor (Ntc, Pt100) as reference for external cold junction compensation. (see 9.2.7, Manual 6.7.3).

'#J' This means that an internal cold junction sensor is to be used for a thermo-

couple (e.g. connector ZA9400-FSx with Ntc). see 9.2.7, Man. 6.7.3).

'\*T' This defines a temperature sensor (Ntc, Pt100) as reference for temperature compensation. (see 9.2.5).

'\*P' This defines an atmospheric pressure sensor as reference for atmospheric pressure compensation. (s. 9.2.6).

'#N' This activates conversion to standard conditions for flow measuring. (see 9.4.9) The remaining 8 characters can be used for the user's own descriptions.

'!' at the end automatically indicates a specific linearization or calibration (see 12.3.11). This cannot be overwritten.

### 12.3.3 Averaging mode

The various averaging methods can be defined via the Averaging mode function; these are described in Section 11.4.2.

Function - No averaging :

**Averaging mode : -----**

Averaging over all active measuring point scans

**CONT**

Averaging over all measuring point scans in a cycle

**CYCL**

### 12.3.4 Locking the sensor programming

The functional parameters for each measuring point are protected by means of the locking mode; this can be set to the desired locking level (see Manual 6.3.12). Before programming you must lower the locking mode to an appropriate level. If you see a dot in the display after the locking mode, this means that this cannot be modified.

#### Locking level

#### Locked functions

0	None
1	measuring range + element flags + output mode
3	+ units
4	+ zero-point correction + gain correction
5	+ base value + factor + exponent
6	+ analog output, start and end
	+ zero-point adjustment, temporary
7	+ limit values, maximum and minimum

Function 'Locking mode':

**Locking level : 5**

In the menu **SENSOR PROGRAMMING** the functions are listed from top to bottom in such a way that the locked functions cannot be selected.

### 12.3.5 Limit values

Two limit values (MAXIMUM and MINIMUM) can be programmed per measuring channel. Exceeding one of these limit values is treated as a fault (in the same way as exceeding a measuring range limit or as sensor breakage). In the display in front of the measured value an arrow appears ▲ or ▼, an alarm signal sounds (to switch this off see 12.5.8), and the alarm relay connected via a relay cable is triggered (see 12.6.2). Limit values can also have relays assigned to them (see 12.4.3). This alarm status remains effective until the measured value returns to within the prescribed limit value by the amount set as hysteresis. Hysteresis is set by default to 10 digits but this can be adjusted to any number between 0 and 99 (see 12.5.7). The event of a limit value being exceeded can also be used to start or stop a measuring operation (see 12.4.3).

#### Function

Enter limit value, maximum (see 10.5): **7 Limit max: 123.4°C**

Limit value, minimum **7 Limit min : -----°C**

To switch off limit values :

**<OFF>**

To switch on limit values :

**<ON>**

### 12.3.6 Scaling, Decimal point setting

To display the electrical signal of a sensor as a measured value in its physical size it is nearly always necessary to perform a zero-point shift and multiplication by a factor. To perform these steps the functions BASE and FACTOR are provided. For a detailed description of scaling, with an example, please refer to the Manual, Section 6.3.11.

**Displayed value** = (corrected measured value - BASE) x FACTOR

The FACTOR can be programmed within the range -2.0000 to +2.0000. For factors above 2.0 or below 0.2 an appropriate decimal point setting should be used by entering EXPONENT. Using EXPONENT the decimal point can be shifted as far to the left (-) or to the right (+) as the display and printer permit. An exponential view of measured values is not possible.

To calculate the scaling values automatically :

**5 Base value:** -----

**5 Factor:** -----

**5 Exponent:** 0

from the actual values and setpoints the **WIZ-ARD** menus include the menu **Scaling**.

Once the scaling values have been programmed and the actual measured value thus modified the correction arrow appears indicating the measured value status (see 10.2).

* SCALING *	
Connector: 0	Channel: 00
Actual value 1:	4.000 mA
Actual value 2:	20.000 mA
Decimal Places:	1
2 Dimension:	°C
Setpoint 1:	-100.0 °C
Setpoint 2:	4000 °C
5 Base:	720.0 °C
5 Factor:	0.3125
5 Exponent:	2
4 SloPe correct:	-----
00:	27.0 °C
<b>CLR</b>	<b>F OK ESC</b>



### 12.3.7 Correction values

Sensors can be corrected by means of the correction values ZERO-POINT and GAIN; (see Manual 6.3.10).

**Corrected measured value** = (measured value - ZERO-POINT) x GAIN

#### Function

Zero-point correction: **4 Zero-Point : -----°C**

Gain correction: **4 Gain : -----°C**

To switch on and off press

**<ON>** or **<OFF>**

Once the scaling values have been programmed and the actual measured value thus modified the correction arrow appears indicating the measured value status (see 10.2).



To reach maximum accuracy multi-point calibration of sensors is now also possible - with option KL (see 12.3.11).

### 12.3.8 Changing the units

For each measuring channel the default units for the measuring range can be replaced with any two-character units; (see Manual 6.3.5). All upper-case and lower-case letters, special characters °, Ω, %, !, [, ], \*, -, =, ~ and space ( ) can be used. The units are shown as two characters after the measured value or programming value.

To **change the units** use the function:

**2 Units : °C**



If you enter **°F** as units the temperature value will be converted automatically from degrees Celsius to degrees Fahrenheit. If you enter **!C** cold junction compensation will be disabled. If you enter the appropriate two characters the following units are generated automatically; for **mls** enter **ms**, for **m³lh** enter **mh**, for **Wlm²** enter **Wm**, and for **g/k** enter **gk**.

### 12.3.9 Selecting the measuring range

If you want to program the connectors yourself or if you often need to change the measuring range you will have to disable the locking mode for the connectors in question by setting the locking level to 0 (see 12.3.4); please note also that for certain transducers a special connector is required (e.g. thermo, shunt, divider, etc., see the table). To activate a new measuring channel first press **<MALL>** to activate all channels, then select the required input channel (see 12.3.1), and then enter the measuring range. When the input for the new measuring range is confirmed all programming values for that input channel will be deleted.

Function - Measuring range selection

**1 RANGE : NiCr**

To accept the selection of all possible measuring channels press **<MALL>**

## 12. Programming using the programming menus

To deactivate a channel press

**<CLR>**

To reactivate a channel press

**PROG** , **PROG**

Programming the range is as for data input (see 10.5

**PROG** , **▲** ... , **PROG**

In the input window all the abbreviations listed in the following table appear one after the other :

**1 RANGE** **FECO**

and an appropriate help window for identifying the sensors

**Connector ZA 9021FSL**  
**Thermocouple type L**  
**-200.0 ... 900.0 °C**

Transducer	Connector / cable / sensor	Measuring range	Units	Display
<b>Pt100-1</b> ITS90	ZA 9000-FS	-200.0... +850.0	°C	P104
Pt100-2 ITS90	ZA 9000-FS	-200.00...+400.00	°C	P204
Pt1000-1 ITS90 (Element flag 1)	ZA 9000-FS	-200.0... +850.0	°C	P104
Pt1000-2 ITS90 (Element flag 1)	ZA 9000-FS	-200.00...+400.00	°C	P204
Pt100-3 ITS90	ZA 9000-FS	0.000...+65.000	°C	P304
Ni100	ZA 9000-FS	-60.0... +240.0	°C	N104
<b>NiCr-Ni (K)</b> ITS90	ZA 9020-FS	-200.0...+1370.0	°C	NiCr
NiCr-Ni (K) ITS90 **	ZA 9020-SS2	-100.00...+500.00	°C	NiC2
NiCroSil-NiSil (N) ITS90	ZA 9020-FS	-200.0...+1300.0	°C	NiSi
Fe-CuNi (L)	ZA 9021-FSL	-200.0... +900.0	°C	FeCo
Fe-CuNi (J) ITS90	ZA 9021-FSJ	-200.0...+1000.0	°C	IrCo
Cu-CuNi (U)	ZA 9000-FS	-200.0... +600.0	°C	CuCo
Cu-CuNi (T) ITS90	ZA 9021-FST	-200.0... +400.0	°C	CoCo
PtRh10-Pt (S) ITS90	ZA 9000-FS	0.0...+1760.0	°C	Pt10
PtRh13-Pt (R) ITS90	ZA 9000-FS	0.0...+1760.0	°C	Pt13
PtRh30-PtRh6 (B) ITS90	ZA 9000-FS	+400.0...+1800.0	°C	EL18
Au-FeCr	ZA 9000-FS	-270.0... +60.0	°C	AuFe
W5Re-W26Re (C) **	ZA 9000-SSC	0.0...+2320.0	°C	WR26
<b>NTC type N</b>	ZA 9000-FS	-30.00...+125.00	°C	NTC
NTC type N **	ZA 9040-SS3	0.000...+45.000	°C	NTC3
PTC type Kty84 **	ZA 9040-SS4	-0.0...+200.0	°C	KTY
<b>Millivolt 1</b>	<b>ZA 9000-FS</b>	<b>-26.000...+26.000</b>	<b>mV</b>	<b>mV 1</b>
Millivolt	ZA 9000-FS	-10.000...+55.000	mV	mV
Millivolt 2	ZA 9000-FS	-260.00...+260.00	mV	mV 2
Volt	ZA 9000-FS	-2.6000...+2.6000	V	Volts
Difference - millivolt 1	ZA 9000-FS	-26.000...+26.000	mV	D 26
Difference - millivolt	ZA 9000-FS	-10.000...+55.000	mV	D 55
Difference - millivolt 2	ZA 9000-FS	-260.00...+260.00	mV	D260
Difference - volt	ZA 9000-FS	-2.6000...+2.6000	V	D2.6

Transducer	Connector / cable / sensor	Measuring range	Units	Display
Sensor voltage	any	0.00...20.00	V	Battery
<b>Milliampere</b>	ZA 9601-FS	-32.000...+32.000	mA	mA
Percent (4 to 20 mA)	ZA 9001-FS	0.00... 100.00	%	%
Ohms	ZA 9000-FS	0.00... 400.00	"Ω	Ohms
Ohms **	ZA 9003-SS3	0.000... 50.000	"Ω	Ohm 1
Frequency	ZA 9909-AK	0... 25000	Hz	Freq
Pulses	ZA 9909-AK	0... 65000		pulses
Digital input	ZA 9000-EK2	0.0... 100.0	%	Input
Digital interface	ZA 9919-AKxx	-65000... +65000		DIGI
<b>Infrared 1</b>	FI A628-1/5	0.0... +200.0	°C	IR 1
Infrared 4	FI A628-4	-30.0... +100.0	°C	IR 4
Infrared 6	FI A628-6	0.0... +500.0	°C	IR 6
<b>Rotating vane, normal 20</b>	FV A915-S120	0.30... 20.00	m/s	S120
Rotating vane, normal 40	FV A915-S140	0.40... 40.00	m/s	S140
Rotating vane, micro 20	FV A915-S220	0.50... 20.00	m/s	S220
Rotating vane, micro 40	FV A915-S240	0.60... 40.00	m/s	S240
Rotating vane, macro	FV A915-MA1	0.10... 20.00	m/s	L420
Water turbine, micro	FV A915-WM1	0.00... 5.00	m/s	L605
Dyn. press. 40m/s with TC + PC	FD A612-M1	0.50... 40.00	m/s	L840
Dyn. press. 90 m/s with TC + PC	FD A612-M6	1.00... 90.00	m/s	L890
Flow sensor SS20 **	ZA9602-SSS	0.50... 20.00	m/s	L920
<b>Rel. humidity, capacitive</b>	FH A646	0.0... 100.0	%H	% rH
Rel. humidity, cap. with TC	FH A646-C	0.0... 100.0	%H	HcrH
Rel. humidity, cap. with TC	FH A646-R	0.0... 100.0	%H	H rH
Humid temperature HT	FN A846	-30.00...+125.00	°C	P HT
<b>Conductivity probe with TC</b>	FY A641-LF	0.0 ...20.000	mS	LF
CO <sub>2</sub> sensor	FY A600-CO2	0.0 ... 2.500	%	CO2
O <sub>2</sub> saturation with TC and PC	FY A640-O2	0 ... 260	%	O2-S
O <sub>2</sub> concentration with TC	FY A640-O2	0 ... 40.0	mg/l	O2-C
<b>Function channels (see 12.3.10)</b>				
* Mixture ratio, with PC	FH A646	0.0 ... 500.0	g/kg	H AH
* Dew-point temperature	FH A646	-25.0... 100.0	°C	H DT
* Partial vapor pressure	FH A646	0.0...1050.0	mbar	H VP
* Enthalpy with PC	FH A646	0.0 ... 400.0	kJ/kg	H En
* Rel. humidity, psychr. with PC	FN A846	0.0 ... 100.0	%H	P RH
* Mixture ratio, with PC	FN A846	0.0 ... 500.0	g/kg	P AH
* Dew-point temp. with PC	FN A846	-25.0 ... +100.0	°C	P DT
* Partial vapor pressure, with PC	FN A846	0.0 ...1050.0	mbar	P VP
* Enthalpy with PC	FN A846	0.0 ... 400.0	kJ/kg	P En
Measured value (Mb1)	any		f(Mb1)	Meas

## 12. Programming using the programming menus

Transducer	Connector / cable / sensor	Measuring range	Units	Display
Difference (Mb1-Mb2)	any		f(Mb1)	Diff
Maximum value (Mb1)	any		f(Mb1)	Max
Minimum value (Mb1)	any		f(Mb1)	Min
Average value over time (Mb1)	any		f(Mb1)	M(t)
Count of averaged (Mb1)	any			n(t)
Avg. val. over meas. pts (Mb2...Mb1)	any		f(Mb1)	M(n)
Sum over meas. pts (Mb2...Mb1)	any		f(Mb1)	S(n)
Total number of pulses (Mb1)	ZA 9909-AK	s.Man6.7.1 0...65000		S(t)
pulse count / print cycle (Mb1)	ZA 9909-AK	s. Man6.7.1 0...65000		S(P)
Alarm value (Mb1)	any	see 12.4.5 0/100	%	Alarm
Thermal coefficient $\bar{q}/(M01-M00)$	ZA 9000-FS	see 11.6.1	W/m <sup>2</sup> K	q/dT
Wet bulb globe temperature	ZA 9000-FS	see 11.6.2	°C	WBGT
Cold junction temperature	any	see 11.2.7	°C	CJ
Volume flow m <sup>3</sup> /h Mb1 · Q	any	see 11.4.9	m <sup>3</sup> /h	Flow
Timer	any	see 11.4.6 0...65000	s	Time
Temp. for refrigerant R22 °	FDA602Lx	-90.0...+79.0	°C	R22
Temp. for refrigerant R23 °	FDA602Lx	-100.0...+26.0	°C	R23
Temp. for refrigerant R134a °	FDA602Lx	-75.0...+101.0	°C	R134
Temp. for refrigerant R404a °	FDA602Lx	-60.0...+65.0	°C	R404
Temp. for refrigerant R407c °	FDA602Lx	-50.0...+86.0	°C	R407
Temp. for refrigerant R410 °	FDA602Lx	-70.0...+70.0	°C	R410
Temp. for refrigerant R417a °	FDA602Lx	-50.0...+70.0	°C	R417
Temp. for refrigerant R507 °	FDA602Lx	-70.0...+70.0	°C	R507

TK = temperature compensation, LK = atmospheric pressure compensation, Mbx = reference channels

\* Humidity variables (Mb1 = temperature, Mb2 = humidity / humid temperature)

++ only via special connectors with internal characteristic (see 12.3.11, others by request)

° 8 measuring ranges for refrigerants, only with device option R (Mb1 = pressure in mbar)

### 12.3.10 Function channels

At the end of the table of measuring ranges and units (see above) under the sub-heading **Function channels** there is a group for representing function parameters in measured value processing or calculated results from linking certain measured values on measuring channels (see Manual 6.3.4). Reference to the actual measuring channels is provided by one or two reference channels. For all function channels the default reference channels Mb1 and Mb2 are available on the appropriate connector; these channels do not need programming.

Function	Function channel	Reference channel 1	Reference channel 2
* Humidity variables, capacitive	on channel 3 or 4	Mb1 = temperature	Mb2 = humidity
* Humidity variables, psychr.	on channel 3 or 4	Mb1 = DT	Mb2 = HT
Function parameter (Mb1)	on channel 2, 3, or 4	Mb1 = channel 1	
Difference (Mb1 - Mb2)	on channel 2, 3, 4 (Mb1)	Mb1 = channel 1	Mb2=M00
Average value over Mb2...Mb1	on channel 2, 3, 4 (Mb1)	Mb1 = channel 1	Mb2=M00
Total value of Mb2...Mb1	on channel 2, 3, 4 (Mb1)	Mb1 = channel 1	Mb2=M00
$\bar{q}/(M01 - M00)$	on channel 2, 3, 4 (q)	Mb1 = channel 1	Mb2=M09
WBGT	on channel 2 (GT)	Mb1 = channel 1	Mb2=M00

**Arrangement of channels on the connectors :**

Once the range has been programmed the standard reference channels can be used (see above). Settings for the reference channels are described in Section 12.4.6. The best approach is to use the **Function channels** wizard.

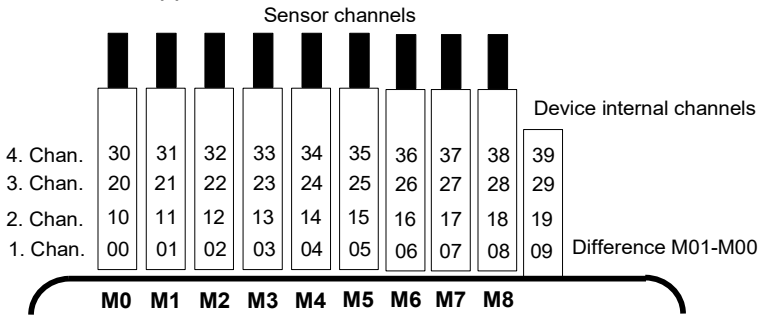

**A new feature is the presence of 4 device-internal channels.** M9 is programmed by default as differential channel M1 – M0; this applies if there are two sensors with the same units and same decimal point position connected at measuring points M0 and M1. However, all four channels can be used in conjunction with any function channels with standard reference channels Mb1 = M1 and Mb2 = M0; i.e. if you want to program a function parameter without reference channel on a device-internal basis, the sensor must be connected to M1.

**Advantage** of device-internal channels :

If several sensors are being used for the same application, they do not have to be reprogrammed and can be freely exchanged without losing their function channel assignment. However, if the whole application operates with just one sensor, then programming on the sensor itself makes more sense.

### 12.3.11 Special measuring ranges ,Linearization ,Multi-point calibration

Thanks to the new ALMEMO special connectors with extra memory for additional data (bigger EEPROM, code E4) the following tasks can now be performed for the first time with elegance :

1. Provision of special measuring ranges with internal characteristic (see 12.3.9)
2. Linearization of signals for voltage, current, resistance, or frequency set by the user
3. Multi-point calibration of all sensors
4. Serial number and calibration data management in the sensor

The 5690-2M system can as a standard feature evaluate all appropriately programmed connectors but only on the master measuring circuit board. Special measuring ranges can be used on selector switch boards so long as they employ the same characteristic as channel M8. With option KL you can yourself, using the AMR-Control software, program a characteristic of up to 35 support values in the EEPROM on the ALMEMO connector. During a measuring operation the measured values between these are interpolated on a linear basis. When correcting non-linear sensors (e.g. with PT100 or thermocouple sensors) first the original characteristics are considered; then the deviations are interpolated on a linear basis and inserted.

**Code** for user-defined linearization / calibration:

Designation with **!TemPeratu!**

If a channel with a characteristic is deactivated or programmed with a different range, the characteristic can subsequently be reactivated by programming the special range 'Lin' using the keypad or command 'B99'.

Other information that can be entered in the extended connector includes the order number, the serial number, the date of the next calibration, and the calibration interval. In internetworked systems this permits automatic monitoring of the calibration intervals (see Fehler: Referenz nicht gefunden, 12.8).

## 12.4 Special functions

On the 5690-2M data acquisition system all ALMEMO® special functions can be accessed via a special menu; these special functions may be needed only occasionally in routine operation but may be very useful in many applications (see Manual 6.10). Some of these functions are highly complex and should only be used if you are fully aware of how they work and what effect they have.

* SPECIAL FUNCTIONS *	
Connector:	1 Channel: 11
Print cycle factor:	01
U-Sensor min:	12.0 U
7 Action max:	Start R1
7 Action min:	Ende R2
6 Analog-start:	0.0 °C
6 Analog-end:	300.0 °C
OutPut function:	MESS
1 Reference ch. 1:	(01)
1 Multiplexer:	(B-A)
Element flags:	IR
Calibration offset:	-12345
Calibration faktor:	43210
<b>M PRINT ESC</b>	

### 12.4.1 Print cycle factor

To adapt data recording to the speed of modification at individual measuring points a print cycle factor can be programmed to between 00 and 99; this will cause certain measuring points to be output less frequently or not at all (see Manual 6.10.6). This print cycle factor is by default completely disabled or set to 01 for all measuring points; i.e. all activated measuring points are output in each cycle. If some other factor e.g. 10 is entered the measuring point in question will only be output every 10th cycle; if 00 is entered it will not be output at all. With data saving similarly it is possible to suppress measured values that are unnecessary and thus save on memory capacity.

Enter print cycle factor (see 10.5) in function:

**Print cycle factor : 01**

To clear the print cycle factor press

**<CLR>**

### 12.4.2 Minimum sensor power supply

As with all ALMEMO® devices the sensor supply voltage on the 5690-2M is monitored. The sensor supply voltage is displayed in the **Power supply menu** (see 12.7). Some sensors, to operate properly, need their own supply voltage and this must be provided by a rechargeable battery or via a mains unit. To prevent measuring errors the minimum sensor voltage needed by each individual sensor can be entered in the **Special functions menu**. If the voltage drops below this value the measured value will be treated as a sensor breakage (display 'L' flashes).

To enter the minimum sensor supply voltage :

**Sensor voltage, minimum : 12.0 V**

To disable voltage monitoring, to delete the value : **<CLR>**

**Sensor voltage, minimum : ---- V**

### 12.4.3 Limit Value Responses

#### Relay assignment

For reporting alarms in the event of a limit value being exceeded alarm relay cables or new V6 relay adapters are used. These relays can be configured individually - as total alarm or separately as maximum / minimum alarm - or they can have individual limit values assigned to them.

If disturbances need to be selectively detected and evaluated, one can simply specify the limit values in the wizard menu **Limit value alarm** and assign these to individual relays; (see Manual 6.10.8).

It is also possible to have a number of limit values assigned to the same relay. If the relay adapter is connected the corresponding relay will automatically be set to variant 2 (Assigned internally). If not, it must be configured to this variant later.

```

LIMITS, ALARM
-----
Select measuring channel:
MO: 216.7 °C
7 Limit max:          300.0 °C
Relay: 0
7 Limit min:          100.0 °C
Relay: 1
Output socket: A2
Use alarm cable, set variant
EA Trigger-Alarm
2: Rx int. assigned
Relay: 01-----
-----
M PRINT ESC
    
```

Or alternatively in the programming menu **Special functions** there are the functions **Action - Max**, **Action - Min** :

To activate relay "xx" in the event of overshooting limit value maximum : 7 **action, maximum** : ----- **xx**

To activate relay "yy" in the event of undershooting limit value minimum : 7 **action, maximum** : ----- **yy**

To clear relay assignment press **<CLEAR>**

The relays can be configured in menu **Output modules** :

To set port 20, socket A2  
 a normally open semiconductor relay  
 to variant 2 (relay assigned internally)

Port: 20                      Socket: A2  
 Relay : NO, 0.5 A  
 2 : Assigned internally

#### Controlling a measuring operation

The exceeding of a limit value can be used not only for reporting an alarm but also for controlling a measuring operation (see Manual 6.6.3). Commands can be assigned to a limit value by means of the functions :

<b>Action, maximum</b>	and	<b>Action, minimum</b>	Rxx	code
Start meas. operation at limit value, max:	7	<b>Action, max:</b>	<b>Start</b>	-- S
Stop meas. operation at limit value, min:	7	<b>Action, min:</b>	<b>Stop</b>	-- E
Manual inquiry at limit value, maximum :	7	<b>Action, max:</b>	<b>Manu</b>	-- M
Zero-set timer 0.1s at limit value, max:	7	<b>Action, max:</b>	<b>TZero</b>	-- T
Execute macro 5...9 at limit value, max:	7	<b>Action, max:</b>	<b>Mac 5</b>	-- 5
To clear action press			<b>&lt;CLR&gt;</b>	



### 12.4.4 Analog start and analog end

The analog output of measured values to the analog output modules (see Manual Ch 5) or to the display as bar chart or line graph must in most cases be scaled to a particular range. You can do this by simply stipulating the start value and end value of the range you want displayed. This range will then be mapped to the analog range 2 V, 10 V, 20 mA or for the display with 100 pixels.

**Program the analog output start**    **6 Analog start : 0.0 °C**

**Program the analog output end**    **6 Analog end : 100.0 °C**

These two parameters, "analog output start" and "analog output end", are also saved in the sensor EEPROM and can thus be individually programmed for each channel; i.e. when channels are switched through manually each measurable variable can be individually scaled.

The flag for switching over from 0 - 20 mA to 4 - 20 mA is programmed via the element flags (see 12.4.8).

For programming all the parameters of an analog output the wizard menu **Analog output** is provided (see 12.6.3).

### 12.4.5 Output function

If the current measured value of the measuring point Mxx is not actually needed but only the maximum, minimum, average, or alarm value, this function can be programmed as output function (see Manual 6.10.4). Saving, analog output, and digital output will then only process the specified function value. As verification for the output function being thus changed the measured value is shown with the symbols listed below (see 10.2).

#### Examples

1. If measured values are being averaged over the cycle the only output value of interest is the average value itself, not the last measured value. With a data logger this saves memory capacity.
2. The analog measured value from dew sensor FH A946-1 is not really significant. If you set limit value, maximum to approx. 0.5 V and program the "alarm value" function, you will then only receive the values 0.0% for dry and 100.0% for dew.

Output function	Verification symbols	menu
Measured value (Mxx)		<b>OutPut function : Meas</b>
Difference (Mxx - M00)	<b>D</b>	<b>OutPut function : Diff</b>
Maximum value (Mxx)	<b>H</b>	<b>OutPut function : Max</b>
Minimum value (Mxx)	<b>L</b>	<b>OutPut function : Min</b>
Average value (Mxx)	<b>M</b>	<b>OutPut function : M(t)</b>
Alarm value (Mxx)	<b>A</b>	<b>OutPut function : Alm</b>

### 12.4.6 Reference channel 1

The calculating functions of the function channels usually refer to one (or two) particular measuring channel(s) (see 12.3.10, Manual 6.3.4). When programming a function channel the reference channel Mb1 is provided automatically by the 1st channel of the associated sensor connector Mxx<sub>1</sub>. The 2nd reference channel Mb2 (for differential value, average value M(n), etc.) is provided initially by measuring point M00. In the function **Reference channel 1** you can also set another measuring point as reference channel - either one specified measuring point or an unspecified measuring point chosen according to the distance relative to the function channel (where -01 is the channel in front of the function channel).

Programming reference channel 1, absolute : **1 Reference channel 1: 01**

Programming reference channel 1, relative : **1 Reference channel 1: -10**

### 12.4.7 Reference channel 2 or multiplexer

With those function channels needing a 2nd reference channel (see above) **Reference channel 1** is followed automatically by the function **Reference channel 2**. In all other cases the **Multiplexer** function can be used to change the input multiplexer and thus the pin assignment in the connector (see Manual 6.10.2).

Programming reference chan. 2, absolute :	<b>1 Reference channel 2: 00</b>
Programming reference chan. 2, relative:	<b>1 Reference channel 2: -01</b>
Measuring inputs B+ and A-, GND-referred	<b>1 Multiplexer: B-A</b>
Measuring inputs C+ and A-, GND-referred	<b>1 Multiplexer: C-A</b>
Measuring inputs D+ and A-, GND-referred	<b>1 Multiplexer: D-A</b>
Differential measuring inputs C+ and B-	<b>1 Multiplexer: C-B</b>
Differential measuring inputs D+ and B-	<b>1 Multiplexer: D-B</b>

### 12.4.8 Element flags

Element flags are available per measuring channel; these can be activated to implement sensor-specific extra functions (see Manual 6.10.3).

Measuring current 1/10 for Pt1000, 5000Ω: (Flag 2:)*	<b>Element flags: I 1/10</b>
Measuring bridge with switch for final value simulation :	<b>Element flags: IR</b>
Digital channel, cyclic evaluation only:	<b>Element flags: Bridge</b>
To deactivate electrical isolation (see 8.4): (Flag 6:)*	<b>Element flags: Cyclic</b>
To deactivate sensor breakage detection :	<b>Element flags: Iso OFF</b>
To switch analog output from 0-20 mA to 4-20 mA :	<b>Element flags: Fi9 6</b>
	<b>Element flags: Br OFF</b>
	<b>Element flags: A 4-20</b>

\* With ALMEMO 5690-2M this element flag is of no significance.

## 12.5 Device configuration

In the **DEVICE CONFIGURATION** menu certain basic settings can be made. The device designation can be used as print header in a log printout or to facilitate assignment in a network. In network operation the device address is indispensable. The baud rate can be adapted for interoperation with external devices. The display backlighting can be set to any one of three levels. The atmospheric pressure setting can be adjusted to compensate certain sensors in particular at different altitudes. The default value for hysteresis for alarm relays can also be modified. The number of channels and the cold junction temperature are displayed for the purposes of device monitoring.

```
* DEVICE CONFIGURATION *
Device designation:
Ahlborn, Holzkirchen
Device: 00          U: 6.05 XY
Baud rate:         9600 Bd
Language:          Deutsch
Lighting level:    1
Lighting duration: 20 s
Contrast:          50 %
Air. Pressure:     1013 mb
Hysteresis:        10
Configuration:    FCR-----
Meas.channels: 40  Active: 05
CJ-Temperature:   25.4 °C
PRINT ESC
```

### 12.5.1 Device designation

In the **Device designation FUNCTION** (see Manual 6.2.4) you can enter any text up to maximum 40 characters in length (see 10.5). This text will then appear in the main menu, in the print header for a measuring operation, and in device lists (software).

Function **Device designation** : Device designation: Ahlborn, Holzkirchen

### 12.5.2 Device address and networking

All ALMEMO® devices can be networked together very easily thus enabling the user to centrally acquire and record measured values from several measuring instruments - even if these are located far apart (see Manual 5.3). To communicate with networked devices it is absolutely indispensable that each device should have its own baud rate setting and its own dedicated address; this is because only one device should respond per command. Before starting network operation ensure therefore that all the measuring instruments involved are assigned different device numbers. The device address for this system is set by means of a **code switch** (6d) located on the rear of the device.

The **Device** function in the **DEVICE CONFIGURATION** menu displays the device address setting, then the device type and version number, and then if applicable an option code (see Manual 6.10.11).

Device address with type, version, option : **Device: 00 5690-2M U:6.05XY**

*Example* : Address: 00, Type: 5690-2, Version: 6.05, Option: XY



In network operation consecutive numbers between 01 and 99 should be used; this ensures that device 00 is not addressed unnecessarily in the event of interruption to the power supply.

### 12.5.3 Baud rate, Data format

The baud rate for all interface modules is programmed on leaving the factory to 9600 baud. In order to avoid unnecessary problems when networking several devices together the baud rate should not be altered; rather the computer or printer should be set to match. If this is for some reason not possible you can, in the **Baud rate** function, enter the values 1200, 2400, 4800, 9600 baud or 57.6, 115.2 kbaud (paying attention not to exceed the maximum baud rate for the interface module). The baud rate setting is saved in the EEPROM on the interface module and thus applies when used with any other ALMEMO device.

Function **Baud rate:**                    **Baud rate:**                    **9600 baud**  
**Data format:** (settings cannot be changed) 8 data bits, 1 stop bit, no parity

### 12.5.4 Language

The user can choose between German / English / French as the interface language in which the functions are labeled in the display; (other languages are also available as options). The soft-keys are international; these cannot be changed. If German is not set as the language outputs via the interface will appear in English. To select the language go to the **Language** function (see 10.5)

: **Language:**                    **German**

### 12.5.5 Backlighting and contrast

The backlighting for the display can be enabled in the selection menus by pressing **<← ON>**; it can be disabled or set to any one of three levels in device configuration with the **Backlighting** function; (please note : backlighting level 3 more than doubles the power consumption). If backlighting is enabled but no mains adapter is connected, the backlighting will go out again automatically after a settable backlighting duration starting as soon as the current key operation has been completed (pause) and will go on again as soon as any key is pressed. The **Contrast** function can be used to set the contrast of the display to any one of 10 levels.

Switch backlighting on at level 1 to 3                    **Backlighting level: 2**  
 Switch backlighting off (level 0)                    **Backlighting level: 0**  
 Enter backlighting duration 20 s to 10 min                    **Backlighting duration: 20 s**

If **backlighting is switched on**,

the status bar will display the symbol:                    \*                    Backlighting on

If backlighting is switched off temporarily, the :                    ✱                    Pause

To switch backlighting on again **without** the function press :                    **<ESC>**

Set the contrast (10 to 100 %) (see 10.5)                    **Contrast: 50 %**

### 12.5.6 Atmospheric pressure

The atmospheric pressure can be set to compensate certain sensors (see 11.2.6). If atmospheric pressure is measured it will appear in this function.

Enter atm. pressure in the **Atm Pressure** function **Atm Pressure: 1013 mbar**

### 12.5.7 Hysteresis

The hysteresis for an alarm triggered in the event of a limit value being exceeded can be set generally for all sensors from 0 to 99 digits (default 10 digits) in the **Hysteresis** function (see 12.3.5 and Manual 6.2.7).

To modify hysteresis (0 to 99) (see 10.5) **Hysteresis : 10**

### 12.5.8 Operating parameters

Certain operating parameters can be configured by the user as software options in the function **Configuration** (see Manual 6.10.13.2).

Change mains frequency noise suppression from 50Hz to 60Hz **Configuration:F-----**

To delete all measured values at the start of a meas. op. **Configuration:-C-----**

Ring memory (values are overwritten if memory full) **Configuration:--R-----**

Immediate output via the interface, oversampling **Configuration:----A---**

Switch signal transmitter off **Configuration:-----S--**

The following parameters can be used to check proper device functioning :

Of 60 possible channels 25 are activated : **Measuring channels:60 active : 25**

Sensor supply voltage 11.7 V = mains operation **Sensor voltage :11.7 V**

Cold junction temperature = socket temperature : **CJTemperature :25.4°C**

## 12.6 Output modules

Data logger ALMEMO® 5690-2M has two output sockets A1 and A2; these can output measured values in either analog or digital form or as an alarm signal. It is also possible to initiate various functions by means of trigger pulses. To cover all possibilities while also keeping the hardware to a minimum all necessary interfaces have been integrated on the ALMEMO® output connectors.

These output modules, just like the sensors, are automatically recognized and shown in the **OUTPUT MODULES** menu.

With the relay trigger modules (in particular module ES5690-RTA5) certain function variants can be configured (see 12.6.2), relays can have certain limit values assigned to them (see 7.5), or analog outputs can be assigned to certain measuring channels. In this menu all ports can be selected and configured accordingly. The connection possibilities are described in the instructions for the output module concerned.

```

*   OUTPUT MODULES   *
-----
Output socket A1:
DK Data cable
0: RS232

Baudrate:           57.6 kBd

Output socket A2:
EA Trigger-Alarm
2: Rx int. assigned
Relay: 01-----

Analogue channel:   00
Analogue value:     +32500

PRINT ESC
  
```

### 12.6.1 Data cables

Via the serial interface you can output cyclic data logs, all the function values from the measuring menus, and all the programming details for the device and for the sensors to a printer or computer. The ALMEMO® data cables and their connection to devices are described in detail in the Manual, Section 5.2. Other modules for networking the devices are described in detail in the Manual, Section 5.3. All available interface modules can be connected to socket A1 (2); this is with the exception of cable ZA 1999-NK, which is used for networking extra devices; this must be connected to socket A2.

In the menu under the socket concerned the following information is displayed :

**Output socket A1:**

Variante 0 : Serial standard interface always active  
The baud rate is saved in the cable connector :

**DK Data cable**  
**0: RS232**  
**Baud rate: 9600 baud**

### 12.6.2 relay trigger analog modules

Whereas, for the purposes of addressing peripheral devices for relay and trigger input (see Manual 5.1.2/3), V5 modules (ZA1000-EAK) provide only one function variant (see Manual XREF), the new V6 relay trigger output modules, e.g. module ES5690-RTA5 (see XREF), offer up to 10 elements. Relays, trigger inputs, or analog outputs can be individually configured regarding their function variant. These external modules can be connected equally well to either output socket A2 or A1 (2); the module is located on the bus. To ensure that all elements can be addressed, each of these sockets has been assigned 10 port addresses..

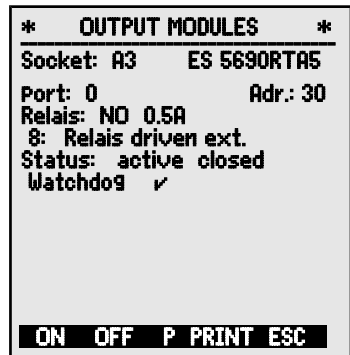

**Socket Connection**

**Port addresses**

<b>A1</b>	V6 output modules to socket A1	10 to 19
<b>A2</b>	V6 output modules to socket A2	20 to 29
<b>B3 to 9</b>	Maximum seven ES5690-RTA5 modules on the bus	30 to 99

In the **Output modules** menu the elements of the output modules can be individually selected and functions programmed as follows : (see Manual, 6.10.9) :

First **select the port** by pressing :

**<P>**; **▲** or **▼**

e.g. Port 0, module B3 (port address 30):

**Port: 30**

The element concerned is recognized :

**Relay :**

- Relay type = NO (normally open) :
- Relay type = NC (normally closed) :
- Relay type = changeover:

**Relay : NO**  
**Relay : NC**  
**Relay : Changeover**

The relay switching mode can be configured to the following **variants**;see 10.5:



## 12. Programming using the programming menus

- 3: Print measured value
  - 4: Start / stop a meas. oper. on level-controlled basis
  - 8: Zero-set a measured value
  - 5: Execute macro 5 (see Manual 6.6.5)
  - 6: Execute macro 6
  - 7: Execute macro 7
  - 8: Execute macro 8
  - 9: Execute macro 9
- 3: Print
  - 4: Start-Stop, level-controlled
  - 8: Zero-set measured value
  - 5: Macro 5
  - 6: Macro 6
  - 7: Macro 7
  - 8: Macro 8
  - 9: Macro 9

### 12.6.3 Analog output

For an analog recording of measured values it is still possible, at sockets A1 and / or A2 (2) to connect V5 output modules with an analog output, e.g. via recording cable ZA1601-RK -1.2..2.0 V (see Manual 5.1.1) and to configure these in the menu **Output modules**. The new V6 relay trigger analog module ZA8006-RTA5 offers the option of up to 10 additional separately configurable analog outputs at its ports, with the following possible output signals (see 12.6.2) with the following possible output signals :

- Voltage 0 to 10 V                      0.5 mV / digit
- Current 0 to 20 mA                      1 µA / digit

**Programming** is as for relay and trigger inputs :

**To select socket and port** press :

**<P>**: **▲** or **▼**

**The following output modes** can be programmed as variants :

- 0: Measured value for the selected measuring channel    **0: Selected measuring channel M00**
- 2: Measured value for a programmed channel :            **2: Assigned internally    M01**
- 8: Programmed analog output (see below) :                **8: Driven externally**

The **analog value** appears below this with the units .:

**Analog value : 12.456 mA**

The **measured value for the selected measuring channel** Mxx is output in variant 0. In this mode the semi-continuous measuring rate (see 12.1.3) is the most suitable; the analog output is processed most frequently in this way.

#### Assigning an analog output to a measuring point

In variant 2 "Assigned internally",

after selecting the Mxx function, you can program the measuring point to be output :

**2: Assigned internally**    **M**    **02**

In this case the continuous measuring rate (see 12.1.3) is better.

#### Scaling the analog output

* OUTPUT MODULES *	
ZA 8006-RTA5	socket B3
Port: 6	Adr.: 36
Analog extern	20 mA
2: Assigned int.	B02
Analog value	6.456 mA
02: 16.7 °C	Temperature
Scaling:	
6 Analog start:	0.0 °C
6 Analog end:	300.0 °C
Curr. output:	4-20mA
<b>M PRINT ESC</b>	



When configuring a measured value output it is also possible, in the same menu, by means of the functions **Analog start** and **Analog end**, to have the measuring range actually used for the measuring point concerned spread over the full 10 V or 20 mA; (see 12.4.4)

**To program the analog output start :**                    **6 Analog start :**                    **0.0°C**  
**To program the analog output end (see 10.5):** **6 Analog end :**                    **100.0°C**

For 20 mA analog outputs only

To choose between 0 - 20 mA and 4 - 20 mA output : **Curr. output t 4-20 mA**

**Programmed analog value output** (see Manual 6.10.7)

In variant 8 "Driven externally"

**8: Driven externally**

the analog output value can be programmed (see 10.5): **Analog value : 5.000 mA**

## 12.7 Power supply menu

The power supply for the measuring instrument is normally derived from mains adapter ZB 1212-NA9 (12V/2.5A). There is also the option of using module ES 5690-AP with 8 AA NiMH rechargeable batteries. The power supply menu displays the current battery voltage to help you estimate the battery's remaining operating time. At 10.4 V the battery symbol in the status bar starts to flash and at 8.8 V the device switches off automatically. The current charge status cannot be displayed more exactly than this because of the different types of load.

Display of supply voltage / battery voltage

Display of actual sensor voltage

* POWER SUPPLY *	
Battery voltage	10.8 V
Sensor voltage	11.6 V
<b>ESC</b>	

**Battery voltage: 10.8 V**

**Sensor voltage : 11.6 V**

## 12.8 Locking, calibration menu (option KL)

In the **Locking and calibration** menu you can lock the right-of-access to certain menus and to certain functions. Here you can also see the serial numbers and calibration data for the device itself and for any sensors attached. With option KL it is possible not only to correct the sensor at several points in the connector itself (see 12.3.11) but also to manage the associated calibration data.

The right-of-access to this and other menus and to certain key functions can be stipulated in detail and protected by password by means of the parameters "Menu" and "Fct".

* Locking, calibration*	
Password:	****
Locking level:	Menu: 0 Fct: 0
Device:	2890-9 6.22
Serial number:	04020123
Next calibration:	01.12.05
Signal for calibration:	✓
Sensor:	Channel: 00
Type:	FHAG46-6
Serial number:	04020123
Next calibration:	01.02.06
Calibr. interval:	12 Month
<b>PRINT ESC</b>	

**Device locking**

No password, locking with new password	<b>Password:</b>	----
Locking protected by password, enter password	<b>Password:</b>	*****
Select locking level for menu and function	<b>Locking:</b>	<b>Menu: 0 Fct: 0</b>

**Menu Locking the menus**

- 0 None
- 1 Calibration menu, except password
- 2 + programming menus, except recording to memory and output from memory
- 3 + recording to memory and output from memory
- 4 + wizard menus
- 5 + measuring menus, except user menu U1

**Fct Locking the functions**

**and keys**

- |   |                                       |
|---|---------------------------------------|
| 0 None  |                                       |
| 1 Data input, switching on and off                | <b>PROG, ON, OFF, ZERO, ADJ</b>       |
| 2 + clear measured data                           | <b>CMEM, CLR, CLRA</b>                |
| 3 + start / stop / output measuring operation     | <b>START/STOP, MANU, ARRAY, PRINT</b> |
| 4 + function selection, measuring point selection | <b>PROG, F▲, M▲</b>                   |

**Calibration data management**

The device type (with version and serial number) and the sensors (with order number and serial number) are displayed. With option KL you can enter the date of the next calibration and the calibration interval in months. If “Calibration message” is activated then, as soon as the next calibration is due, a message to this effect will appear when the device is switched on.

## 13. TROUBLE-SHOOTING

Data acquisition system ALMEMO 5690-2M can be configured and programmed in many versatile ways. It is suitable for connecting a wide variety of very different sensors, additional measuring instruments, alarm signaling devices, and peripheral equipment. Given these numerous possibilities the device may in certain circumstances not behave quite as expected. The cause of such unexpected behavior is only very rarely a device defect; more usually it is incorrect operation by the user, an invalid setting, or unsuitable cabling. In such event try to pinpoint and clear the problem with the aid of the following tests.

**Error** No display, display malfunction, keys do not react

**Remedy** Check the power supply, charge the battery, switch off and then on again.

If necessary, re-initialize; (see 7.5).

**Error** Measured values are incorrect.

**Remedy** Check all the channel programming very carefully, especially the base value and zero-point (sensor programming and special functions).

**Error** Fluctuating measured values or the system hangs in mid-operation.

**Remedy** Check the cabling for any inadmissible electrical connections.

Unplug any suspicious sensors.

Connect hand-held sensors in air or phantoms (for thermocouples short-circuit AB, for PT100 sensors use 100 $\Omega$ ) and check.

Connect the sensors again one at a time and check successively.

If a fault persists for any one connection, then check all wiring; if necessary, insulate the sensor and eliminate interference by using shielded or twisted wiring.

**Error** Data transmission via the interface does not function.

**Remedy** Check interface module, connections, and settings.

Are both devices set to the same baud rate and transmission mode ? (see 12.5.3)

Is the correct COM interface on the computer being addressed ?

Is a printer in the ONLINE status ?

Are the handshake lines DTR and DSR active ?

To check the data flow and the handshake lines a small interface tester with LEDs comes in very handy; (in ready-to-operate status the data lines TXD, RXD carry negative potential of approx. -9V and the LEDs light up green, whereas the handshake lines DSR, DTR, RTS, CTS carry approx. +9V positive voltage and the LEDs light up red; for the duration of data transmission the data LEDs must flash red).

Test data transmission by means of a terminal (AMR-Control, WIN-Control, WINDOWS-Terminal).

Select output channel interface U using command 'A1',

Address the device using its assigned device number 'Gxy' (see Manual 6.2.1).

Enter <Strg Q> for XON, if the device is in the XOFF status.

Check the programming by means of 'P15' (see Manual 6.2.3).

Test the transmit line by entering a cycle using command 'Z123456' and check in the display.

Test the receive line by pressing **<PRINT>** and check in the display.

**Error** Data transmission in the network does not function.

**Remedy** Check to ensure that all devices are set to different addresses.

Address all devices individually via the terminal with command 'Gxy'.

Addressed device is OK if at least 'y CR LF' is returned as echo.

If transmission is still not possible, unplug the networked devices.

Check all devices individually on the data cable to the computer; (see above).

Check the wiring for short-circuit or crossed wires.

Are all network distributors supplied with power ?

Network the devices again one at a time and check successively; (see above).

If, after performing the above-listed checks and remedial steps, the device still fails to behave as described in the operating instructions, it must be returned to our factory in Holzkirchen, accompanied by an explanatory note, error description, and if available test printouts. With the AMR-Control software you can print out screen-shots with the relevant programming and save and / or print out a comprehensive 'function test' in the device list or terminal operations.

## 14. DECLARATION OF CONFORMITY

Ahlborn Mess- und Regelungstechnik GmbH declares herewith that measuring instrument ALMEMO® 5690-2M carries the CE label and complies in full with the requirements of EU directives relating to low voltage and to electromagnetic compatibility (EMC) (89/336/EWG). The following standards have been applied in evaluating the product.

Safety / security: EN 61010-1:2001

EMC: EN 61326: 2006



If a product is modified in any manner not agreed with us in advance, this declaration becomes void.

When using the sensor with an extension care must be taken to ensure that wiring is not laid alongside or close to high-voltage power cables and that it is, if necessary, properly shielded so as to prevent spurious interference being induced in the system.

The following advisory notes must be observed when operating the device :

Using the device in strong electromagnetic fields may aggravate measuring errors (<50 µV at 3 V/m and 1.5 meters thermocouple sensor). After exposure to such irradiation ceases, the device will again operate within its technical specifications.

## 15. APPENDIX

### 15.1 Technical data

(see Manual 2.3)

#### Measuring inputs :

**Master measuring circuit board MM-A9:** 9 ALMEMO® sockets for ALMEMO® flat connectors

Measuring channels : 9 primary channels, electr. isol., maximum 31 additional channels for double sensors and function channels

A/D converter : Delta - sigma, 24-bit, 2.5 / 10 / 50 / 100 meas. operations per second, adjustable 1 to 100

Sensor power supply : Total mains : 12V 400mA, recharg. batt.: 9 to 11.5V 200mA

**Selector switch board U-A10:** 10 ALMEMO® sockets, suitable for ALMEMO® flat connectors  
10 channels, electrically isolated, 30 additional channels with sensor power supply, 2 slots

**Selector switch board U-MU:** 10 inputs, electr. isol., via 10x MU connector without sensor power supply, 30 additional channels, 1 slot

**Selector switch board U-TH:** 10 inputs, electr. isol., via miniature thermocouples without sensor power supply, 30 additional channels, 1 or 2 slots  
If arranged in series one dummy panel must be inserted, 4 DU

**Selector switch board U-KS:** 10 inputs, electrically isolated, via 2 clamp connectors without sensor power supply, 30 additional channels, 1 slot

**Option KSU:** 10 inputs A-C, divider 100/1, accuracy 0.1% (22°C), drift 0.003%/K

**Option KSI :** 10 inputs A-B, with shunt 2 Ohms, accuracy 0.1% (22°C), drift 0.005%/K

**Outputs:** 2 ALMEMO®-Sockets for all output modules, alarm signaling device internally

#### Standard equipment

Display Graphics 128 x 128 pixels, 16 rows of 4 mm

Operation : 9 keys (4 soft-keys and cursor block)

Memory: Memory card, drive, and USB card reader

Option S: 512-KB EEPROM (64,000 to 100,000 measured values)

Cannot be used at 100 measuring operations per second.

Date and time-of-day : Real-time clock, buffered with lithium battery

Microprocessor : M16C62P

**Power supply :** external 10 to 13 VDC

Mains adapter : ZA 1212-NA9, 230 VAC to 12 VDC, 2.5 A

Rechargeable battery in module AP : 8 NiMH AA batteries, 9 to 11 V, 1600 mAh

Current consumption Active mode: approx. 37 mA (without input and output modules)

Backlighting 1: approx. 46 mA

Backlighting 2: approx. 60 mA

Backlighting 3: approx. 75 mA

Sleep mode approx. 50 uA

Selector switch boards : approx. 5 mA

## Housing :

19-inch desktop housing, 32 DU	WxHxD 179 x 158 x 232 mm, polystyrene shielded
19-inch desktop housing, 84 DU	WxHxD 444 x 158 x 232 mm, polystyrene shielded
19" sub-rack, 84 DU	WxHxD 483 x 132 x 273 mm

## Suitable conditions

Operating temperature	-10 to +50 °C	(storage temperature -20 to +60 °C)
Ambient relative humidity :	10 to 90 % rH	(non-condensing)

## Product overview

## Order no.

### Data acquisition system ALMEMO® 5690-2M

9 inputs, maximum 40 channels, 2 outputs, cascable interface,  
9 keys, LCD graphics display, real-time clock, memory card,  
USB card reader, mains unit 12 V / 2.5 A

in 19-inch desktop housing, 32 DU, 6 slots	MA 56902M09TG3
in 19-inch desktop housing, 84 DU, 19 slots	MA 56902M09TG8
in 19-inch sub-rack, 84 DU, 19 slots	MA 56902M09BT8

### Options

S: Built-in 512-KB EEPROM memory	OA 5690-S
Q4: Measuring rate 400 mops but only for 1 measuring point	SA 0000-Q4
R: Measuring ranges for temperature display for 8 refrigerants	SB 0000-R
KL: Linearization, multi-point calibration, calibration data management	OA 5690-KL
Selector switch board U-A10 with 10 inputs, electrically isolated, for ALMEMO® flat connectors, 10 to 40 channels, 2 slots	ES 5690-UA10
Selector switch board U-MU with 10 inputs, electrically isolated, Sensor connector with 10x MU connector, 10 to 40 channels, 1 slot	ES 5690-UMU
10x MU connector for 10 sensors, 10 to 40 channels	ZA 5690-MU
Selector switch board U-TH with 10 inputs, electrically isolated, Sensor connector with thermocouple, 10 to 40 channels, 1 or 2 slots	ES 5690-UTH
Selector switch board U-KS with 10 inputs, electrically isolated, Sensor connector with clamp connector, 10 to 40 channels, 1 slot	ES 5690-UKS
Type KSU: All inputs for 10 V with 100:1 divider	ES 5690-UKSU
Type KSI: All inputs for 20 mA with shunt	ES 5690-UKSI
Trigger output interface with 2 trigger inputs, 4 semiconductor relays (option R02) 2 analog outputs, electrically isolated, -4 to +10 V or 0 to 20 mA	ES 5690-RTA5 OA 8006-R02

### Accessories

Micro SD card, minimum 128 MB	ZB 1904-SD
DC power cable, 10 to 30 VDC, 12 V / 0.25 A, electrically isolated	ZB 3090-UK
DC power cable, 10 to 30 VDC, 12 V / 1.25 A, electrically isolated	ZB 3090-UK2
ALMEMO® data cable with USB interface, electr. isol., max. 921.6 kbaud	ZA 1919-DKU
ALMEMO® data cable with V24 interface, electr. isol., maximum 115.2 kbaud	ZA 1909-DK5
ALMEMO® network cable, electrically isolated, maximum 115.2 kbaud	ZA 1999-NK5
ALMEMO® data cable with Ethernet interface, electr. isol., max. 115.2 kbaud	ZA 1945-DK
ALMEMO® input / output cable V6 for triggering and limit value alarms	ZA 1006-EKG
ALMEMO® recording cable, not electrically isolated, -1.25 to 2.00 V	ZA 1601-RK

## 15.2 Index

Action, maximum and Action, minimum	12.4.3	72
activation mode	12.6.2	79
additional channels	8.2	20
alarm relay cables	12.4.3	72
AMR-Control	5.1.3	16
Analog output	12.6.3	80
Analog start and analog end	12.4.4	73
ARRAY	11.4.4	42
Atmospheric pressure	12.5.6	76
Atmospheric pressure compensation	11.2.6	35
Averaging	11.4	40
Averaging mode	12.3.3	41, 63
Averaging over individual manual measuring	11.4.3	41
Averaging over measuring points	11.4.8	45
Averaging over the cycle	11.4.7	44
Averaging over the measuring time,	11.4.5	43
backlighting	10.1	27
Backlighting	12.5.5	76
bar charts	11.5.1	47
Base value	12.3.6	64
Baud rate	12.5.3	76
calibration data management	12.3.11	70
Changing the units	12.3.8	65
Check lamps	1.2	2f.
CJTemperature	12.5.8	77
Clearing the memory	12.2.6	61
code switch	8.3	21
Code switch	1.2	4
Code switches	1.2	3
Cold junction compensation	11.2.7	36
cold junction temperature	11.2.7	36
Cold junction temperature	12.5.8	77
compensation	11.2	32
Configuration	12.5.8	77
Connecting the transducers	8	20
Connection socket DC	1.2	3
contact status	12.6.2	79
continuous measuring point scan	12.1.3	54
contrast	12.5.5	76
conversion rate	12.1.3	54
Correction values	12.3.7	65
Cross-section	11.4.9	46
Curr. output t	12.6.3	81

cycles	12.1	53
Cyclic output	11.3.2	37
Data buffering	7.6	19
Data cables	12.6.1	78
Data format	12.5.3	76
Data input	10.5	29
Date	12.1.1	53
Date and time-of-day of maximum value	11.1.2	31
DC socket	7.1	18
Decimal point setting	12.3.6	64
Declaration of conformity	14	84
Designation	12.3.2	62
Device address	12.5.2	75
Device configuration	12.5	75
Device designation	12.5.1	75
Device-internal channels	8.2	20
Diameter	11.4.9	46
differential channel	8.2	20
Differential measurement	11.5.2	47
Display	10	27
Display of several measuring points	11.5	47
electrically isolated	8.4	23
Element flags	12.4.8	74
End time	12.1.4	55
Exponent	12.3.6	64
Extending the measuring points	8.3	21
External DC voltage supply	7.2	18
Factor	12.3.6	64
Fail-safe mode	12.2.5	60
File name	12.2.2	56, 58
Function channels	12.3.10	68
Function keys	10.3	28
Function printouts	11.7.3	52
Function selection	10.4	29
Functions of the ALMEMO 5690-2M	5.1	12
Gain correction	12.3.7	65
Ground socket	1.2	3
Housing	15.1	86
hysteresis	12.3.5	64
Hysteresis	12.5.7	77
Initial commissioning	6	17
input channel	12.3.1	62
Introduction	5	12
Inverted relay control	12.6.2	79



keypad	10	27
Keypad	1.1	2
Language	12.5.4	76
level of smoothing	11.4.1	41
Limit Value Responses	12.4.3	72
Limit Value Responses	12.4.3	72
Limit values	12.3.5	64
line graph	11.3.5	39
Linearization	12.3.11	70
Locking the sensor programming	12.3.4	63
macro	12.6.2	80
Mains operation	7.1	18
manual measuring point scan	11.3.1	37
Max time	11.1.2	31
Measured data, recording	12.2.2	57
Measured value correction	11.2	32
Measuring	11	30
Measuring channels	12.5.8	77
measuring duration	11.4.6	43
Measuring duration	12.2.2	55, 58
Measuring inputs	8.2	3, 20
Measuring inputs	15.1	4, 85
measuring menus	11	30
Measuring operations	5.1.2	14
Measuring point designation	12.3.2	62
Measuring point scan	11.3	37
Measuring points list	11	30
Measuring points list	11.5.3	48
Measuring rate	12.1.3	54
Measuring time	11.4.6	43
Measuring with a measuring point	11.1	31
Memory	12.2.1	56
memory activation	12.1.2	53
memory card	12.2.1	56
memory output	11.3.3	38
Memory output	12.2.6	60
Memory space	11.3.3	38
Menu configuration	11.7.2	51
Menu Measuring points list	11.5.3	48
Menu Multi-channel display	11.5.1	47
menu selection	10.1	27
Min time	11.1.2	31
Minimum sensor power supply	12.4.2	71
Module AP	1.2	3

Module MM-A9	1.2	3
Module RTA5	1.2	4
Module U-A10	1.2	4
Module U-KS	1.2	4
Module U-MU	1.2	4
Module U-TH	1.2	4
Monitor mode	12.2.5	59
Multi-channel display	11.5.1	47
Multi-point calibration	12.3.11	70
multimedia card	1.1	2
multiplexer	12.4.7	74
Networked measuring	11.4.4	42
networking	12.5.2	75
Numbering of measuring operations	12.2.3	58
ON	10.1	27
Once-only output	11.3.1	37
Operating parameters	12.5.8	77
Operation with rechargeable battery	7.3	18
output format	12.1.2	53
output format	11.3.2	38
Output function	12.4.5	73
Output menu functions	11.3.4	38
Output modules	12.6	77
Output sockets	1.2	3
P-OFF	10.1	27
Peak value memory	11.1.2	31
Potential separation	8.4	22
power failure	12.6.2	79
Power supply	15.1	18, 85
Power supply menu	12.7	81
Print cycle factor	12.4.1	71
Process control	5.1.3	15
Product overview	15.1	86
Programmed analog value output	12.6.3	81
Programming	12	53
programming menus	12	53
rechargeable battery module	5.1	12
Reference channel 1	12.4.6	74
Reference channel 2	12.4.7	74
refrigerants,	12.3.9	68
Reinitialization	7.5	19
relay adapters	12.4.3	72
Relay assignment	12.4.3	72
relay trigger analog modules	12.6.2	78

right-of-access	12.8	81
Ring memory	12.2.2	57
Safety instructions	4	10
Scaling	12.3.6	64
Scaling the analog output	12.6.3	80
Scope of delivery	3.2	9
select the port	12.6.2	78
Selecting a measuring point	11.1.1	31
Selecting the measuring range	12.3.9	65
selector switch board U-A10	8.3	21
Selector switch board U-KS	8.3	22
Selector switch board U-MU	8.3	21
Selector switch board U-TH	8.3	22
Semi-continuous measuring point scan	12.1.3	54
Sensor adjustment	11.2.3	33
Sensor breakage	10.2	28
sensor power supply	12.4.2	71
Sensor programming	12.3	13, 61
Sensor supply	7.4	19
Sensor voltage	12.5.8	77
Sensor voltage, minimum	12.4.2	71
Set measured value to zero	11.2.1	32
setpoint entry	11.2.4	34
Sleep mode	12.2.5	59
sliding average	11.4.1	41
Smoothing out meas. val.	11.4.1	41
Software	5.1.3	16
Special functions	12.4	70
special measuring operations	11.6	49
Special measuring ranges	12.3.11	70
Standard display	11.1	31
Standard equipment	15.1	85
Start time	12.1.4	55
Starting and stopping measuring operations	12.2.4	58
Status symbols	10.2	28
Suitable conditions	15.1	86
Switching ON / OFF	7.5	19
Technical data	15.1	85
Temperature compensation	11.2.5	35
Thermal coefficient	11.6.1	49
Time constant	11.4.1	41
time-of-day	12.1.1	53
timer	11.4.6	43
Times	12.1	53

To switch off the device	10.1	27
Transducers	8.1	20
Trigger inputs	12.6.2	79
Trouble-shooting	13	83
Two-point adjustment	11.2.4	34
user menu	11.7.2	51
User menus	11.7	50
Volume flow measurement	11.4.9	46
Warranty	3.1	8
Waste disposal	3.3	9
Wet bulb globe temperature	11.6.2	49
WIN-Control	5.1.3	16
wizard menu	11.4	40
Wizard menu	11.6	49
Zero-point adjustment	11.2.2	33
Zero-point correction	12.3.7	65

## 15.3 Your contact person

Ahlborn Mess- und Regelungstechnik GmbH,  
 Eichenfeldstraße 1-3, D-83607 Holzkirchen, Germany  
 Tel. +49(0)8024/3007-0, Fax +49(0)8024/300710  
 Internet: <http://www.ahlborn.com>, e-mail: [amr@ahlborn.com](mailto:amr@ahlborn.com)

**We take every possible care but the risk of inaccuracy  
 can never be altogether excluded.**

**We reserve the right to make technical changes without advance notice.**